

*Full Length Research Paper*

# Separation of fetal electrocardiography (ECG) from composite ECG using adaptive linear neural network for fetal monitoring

M. S. Amin<sup>1\*</sup>, Md. Mamun<sup>2</sup>, F. H. Hashim<sup>1</sup> and H. Husain<sup>1</sup>

<sup>1</sup>Department of Electrical, Electronic and Systems Engineering, Universiti Kebangsaan Malaysia 43600 Bangi, Selangor, Malaysia.

<sup>2</sup>Smart Engineering System Research Group, Universiti Kebangsaan Malaysia, 43600 Bangi, Selangor, Malaysia.

Accepted 23 September, 2018

The signal strength of the maternal ECG (MECG) is usually many times that of the fetal ECG (FECG). Separating FECG from abdominal ECG (AECG) is therefore always a challenge. Some multiple-lead algorithms use the thoracic MECG to cancel the MECG in the AECG to get FECG, though this is inconvenient for the patient during long-term monitoring. Hence, this paper describes an adaptive method to separate fetal ECG from composite electrocardiography (ECG) that consists of both maternal and fetal ECGs by using adaptive linear neural network (ADALINE) for easy fetal monitoring. The input signal is the maternal signal and the target signal is the composite signal. The network emulate maternal signal as closely as possible to abdominal signal, thus only predict the maternal ECG in the abdominal ECG. The network error equals abdominal ECG minus maternal ECG, which is the fetal ECG. The characteristic that enables fetal extraction is due to the correlation between maternal ECG signals and the abdominal ECG signal of pregnant woman. A graphic user interface (GUI) program is written in Matlab to detect the changes in extracted fetal ECG by different values of momentum, learning rate and initial weights used in the network. However, the learning rate, momentum and initial weights are adjusted until the results are reasonably well. It is found that filtering performs best by high learning rate, low momentum and small initial weights.

**Key words:** Neural network, fetal monitoring, fetal electrocardiography (ECG), QRS, maternal ECG, pregnancy.

## INTRODUCTION

Biomedical signal means a collective electrical signal acquired from any organ that represents a physical variable of interest where the signal is considered in general a function of time and is describable in terms of its amplitude, frequency and phase. FECG is a biomedical signal that gives electrical representation of fetal heart rate to obtain the vital information about the condition of the fetus during pregnancy and labour from

the recordings on the mother's body surface. The FECG signal is a comparatively weak signal (less than 20% of the mother ECG) and often embedded in noise. The fetal heart rate lies in the range from 1.3 to 3.5 Hz. The fetal heart rate (FHR) monitoring enables accurate measurement of fetal cardiac performance, including transient or permanent abnormalities of rhythm. Sometimes, the FECG is the only information source in early stage diagnostic of fetal health and status. The FECG is very much related to the adult ECG, containing the same basic waveforms, including the P-wave, the QRS complex and the T-wave. The PQRST complex, as shown in Figure 1, is an electric signal produced by the contraction of the

\*Corresponding author. E-mail: [amin.syedul@gmail.com](mailto:amin.syedul@gmail.com). Tel: +603-89216316. Fax: +603-89216146.

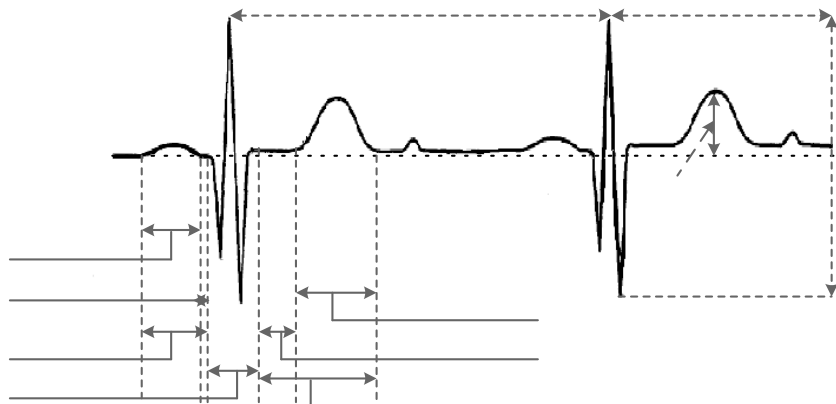

**Figure 1.** Fetal ECG showing key features: the PQRST complex.

heart's muscle called myocardium and it is composed of three parts:

1. The P-wave reflects the contraction of the atria.
2. The QRS-complex is associated with the contraction of the ventricles. Due to the magnitude of the R-wave, it is extremely reliable.
3. The T-wave, which corresponds to the repolarisation phase which follows each heart contraction.

The delay associated to the R-R interval leads to the heartbeats frequency. R-R interval gives useful information for the heart condition.

During the last 20 years, the QRS detection has been one of the most frequently addressed tasks in ECG signal processing (Poli et al., 1995; Hasan et al., 2009; Algunaidi et al., 2018). However, the reliability of the detection has been a question when the signal is accompanied by maternal signal and various sources of noise contamination, such as baseline drifts, motion artifacts and muscular activity.

The recording and monitoring of the FHR from electrodes on the maternal abdomen is the most convenient option for an ambulatory recorder, although, it involves overcoming several difficulties. The difficulty arises in detecting the fetal QRS complexes from the AECG signal, which consists of both the MEGC and FECG. This composite signal may also contain a relatively large amount of noise, and may be further distorted by muscle and breathing movements. A relatively weak FECG also causes difficulties. The signal strength of the MEGC is usually many times that of the FECG. Therefore, it is definitely an issue if the maternal and fetal ECG QRS's coincide with each other. This causes the MEGC to completely overlap the FECG so that only the MEGC QRS is detectable. To overcome the aforementioned problems, some multiple-lead algorithms

use the thoracic MEGC to cancel the MEGC in the AECG to get FECG (Khamene and Negahdaripour, 2000), though this is inconvenient for the patient during long-term monitoring.

Fetal signal resides within abdominal ECG of pregnant woman, together with the maternal signal. Maternal signal is the dominating ECG in the abdominal ECG and is easily susceptible to noise corruption due to its weaker amplitude (Costa and Moraes, 2000). Maternal ECG needs to be filtered out from abdominal ECG of pregnant woman, before the fetal ECG can be fed into QRS detection network. QRS complex detection is important, so that RR-interval can be extracted for monitoring of fetal condition. It is also important in determining the fetal heart rate and in detecting multiple fetuses during pregnancy. It is mostly useful during labor and delivery (Azad et al., 1998; Vullings et al., 2009).

Recent research shows that the nonlinear domain can be modeled more accurately with artificial intelligence technologies. Some approaches like fuzzy logic and moving averaged have been proposed to extract fetal ECG from abdominal ECG of pregnant woman (Hasan et al., 2009; Park et al., 1992). Among different artificial intelligence tools, neural networks are increasingly applied to detect and extract fetal ECG (Rodrigues et al., 2001). Neural network is chosen, mainly because it is adaptive to the nonlinear and time-varying features of ECG signal. It can be trained to recognize the normal waveform and filter out the unnecessary artifacts.

The network needs to consider the existence of noises in the ECG signal, including power line interference, motion artifacts, baseline drift, ECG amplitude modulation with respiration and other composite noises beside maternal signal. The noise can cause inaccurate detection of QRS complex.

In this paper, the framework of fetal ECG extraction using adaptive neural network is proposed. Adaptive

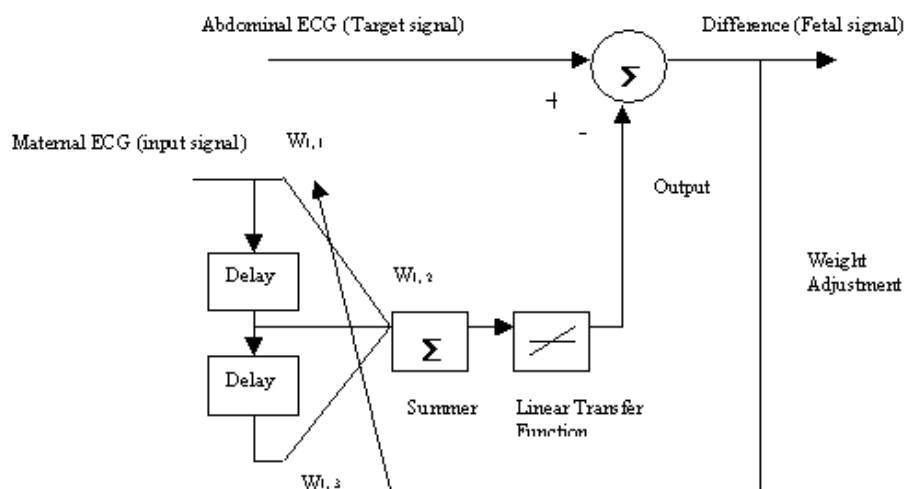

**Figure 2.** Adaptive linear neural network filter architecture.

linear neural network filter is trained to cancel out the maternal signal. It is better than conventional filtering, because subtraction is used instead. It can avoid eliminating desirable signal.

## DESIGN OF ADAPTIVE LINEAR NETWORK FILTER FOR FETAL ECG EXTRACTION

The adaptive linear neural network filter has linear transfer function (Widrow and Stearns, 1985; Ravindrakumar and Raja, 2017; Wenjuan et al., 2017). It uses least mean square (LMS) learning rule. The adaptive linear neural network filter can respond to changes in its environment as it operates. The block diagram of adaptive linear neural network filter architecture is shown in Figure 2. Linear networks that are adjusted at each time step based on new input and target vectors can find weights and biases, which minimize the network's sum-squared error for recent input and target vectors.

The adaptive linear neural network is designed to extract the fetal ECG from abdominal ECG of pregnant woman. The characteristic that enables fetal extraction is due to the correlation between maternal ECG signals with the abdominal ECG signal. The network makes the input signal, noisy maternal ECG, as closely as possible to the target signal (abdominal signal), thus the error between the maternal signal and abdominal signal would be the fetal signal (Sahin et al., 2017).

The adaptive linear neural network (ADALINE) architecture uses the adaptive filtering approach, that is the combination of ADALINE and delay line. According to the concept of the delay line, the input signal MECCG enters and passes through the  $N-1$  delays and the output

of the delay line is an  $N$ -dimensional vector, made up of the input signal at the current time, the previous signal, which is fed to the ADALINE. For the less complexity, the value of  $N$  is considered 2. The adaptive filter linear neural network as shown in Figure 2 where the MECCG, which is predicted and closely to the AECG, passes through the 1 delay and the delayed output is multiplied by the two corresponding initial weights. After addition of the weighted output, it passes through the linear activation function. Finally, the output of the network was detracted from the target input (AECG) and to reduce the difference between input and target signal (weight) has been updated every step. Therefore, the difference is considered the FECG by suppressing from the AECG.

The maternal ECG, which is the signal to be predicted, enters into network through tapped delay line. The value that enters the network is the current value. The two outputs of the tapped delay lines are actually the previous values of current ECG value. The three values are multiplied with three weights value. Three weighted values enter a summer and linear transfer function. Since the target is the abdominal ECG of pregnant woman, the network changes the weight on each time step to minimize the error. If the error is zero, then the network output is exactly equal to target ECG.

## PRESENTATION OF WORK, ANALYSIS AND DISCUSSION

A GUI program was written in Matlab to detect the changes in extracted fetal ECG by different values of momentum, learning rate and initial weights used in the network. Three signals were shown in the program. They were target signal (the abdominal ECG of pregnant

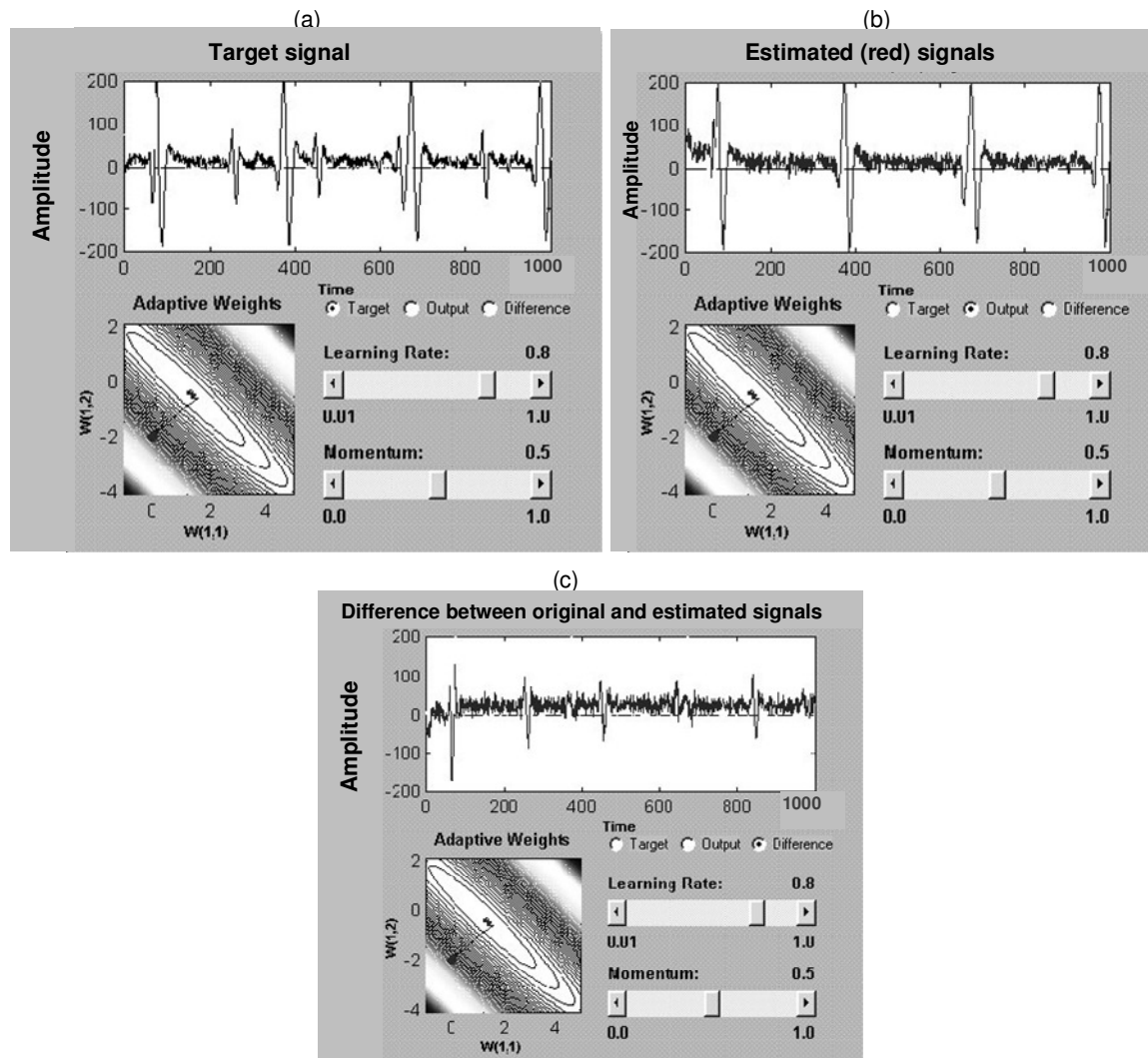

**Figure 3.** Network in noisy environment; (a) target signal, (b) estimated signal and (c) difference signal (fetal ECG).

woman), output or the signal estimated from network (which was close to maternal ECG) and the difference between these two signals (which was the fetal signal). Three radio buttons were used to choose which signal to display.

First, a smooth and noise free signal was used to extract the fetal ECG. Two neurons were used; therefore, the network was a two-weight network. The learning rate and momentum was set as 0.8 and 0.5, respectively. The difference between the target and estimated signal, which is fetal ECG signal that need to be extracted, showed a satisfactory waveform.

At the second step, noisy signal was fed into the network. The same learning rate, momentum and initial weights were used to compare the difference between smooth signals and noisy signals. Since the input was

noisy, the estimated signal was also quite noisy. When the noise was too high, the amplitude was almost equivalent to the amplitude of the fetal ECG. To get a better signal for detecting QRS complex, the fetal ECG was raised to the power of two, thus the peaks was larger than the noise. The noisy target signal, the estimated signal and the difference between target and estimated signals are shown in Figure 3.

The effects of learning rate and momentum on fetal ECG extraction were also studied. When the learning rate was set to very small values, the estimated output signal did not resemble the maternal ECG component in abdominal ECG of pregnant woman. The estimated signal was either too large or too small.

Since not all the maternal ECG was estimated, the subtraction between the estimated ECG and target ECG

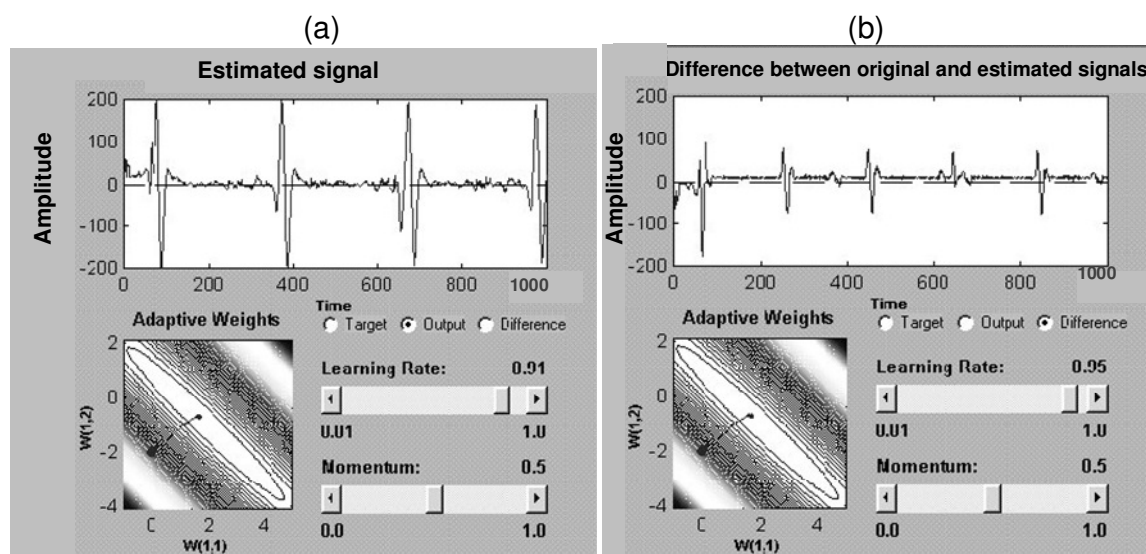

Figure 4. (a) Estimated signal and (b) difference signal (fetal ECG) when learning rate was high.

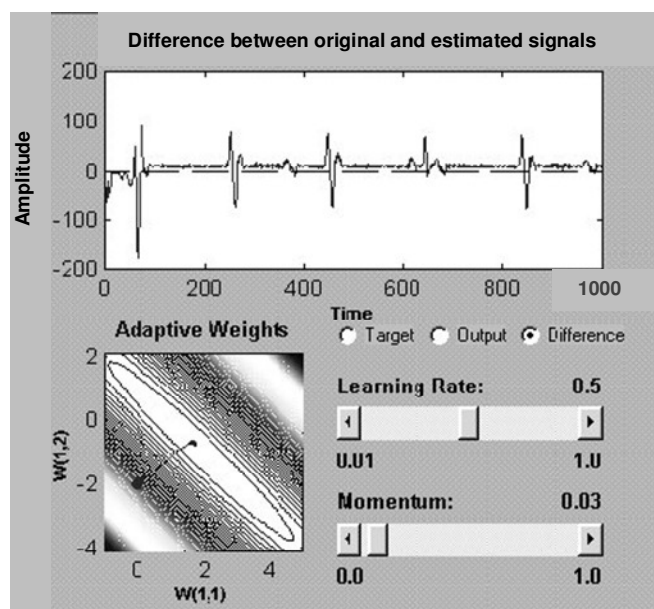

Figure 5. Difference signal (fetal ECG) when momentum was low.

will not produce the desired fetal ECG. Some parts of the maternal ECG were still included. It shows that before 500 samples, the fetal ECG still consists of maternal ECG. Therefore, low learning rate value was not suitable. When high value of learning rate was used, the estimated signal was very close to maternal ECG, because the input maternal ECG was closely correlated to the target abdominal ECG of pregnant woman. The estimated and the difference signal are shown in Figure 4

when learning rate was high.

When high value of momentum was used, the global minimum error surface was missed out, causing the fetal ECG extracted incorrect. It was found that low value of momentum produces good results as shown in Figure 5.

Another factor that affects the output of the network was the initial weights. The weights were randomized at small values at the beginning of the training. However, when the weights were too high, the network had difficulties adjusting the weight. The network reached saturation easily; causing no further improvement to the network to be done. The results were reasonably well with the moderate initial weights as shown in Figure 6.

Adaptive linear neural network filter was used to reduce the noise by functioning similar as moving average windows. The noise was greatly reduced with delay neuron equals to 6 as shown in Figure 7. However, when neuron number was decreased to 2, the output was still quite noisy. When the number of delay neuron was increased to a large number 12, the output was greatly attenuated. Care must be taken in order for the right number of delay neurons to be chosen.

## Conclusion

The proposed approach of using adaptive neural network to extract fetal ECG was successfully designed, implemented and tested. The output was reasonably well in both normal and noisy abdominal ECG of pregnant woman. By using adaptive filter, desirable signal will not be filtered out, like in conventional filter method. Instead, it is subtracted out by comparison between input and target. Therefore, an appropriate window size or frequency

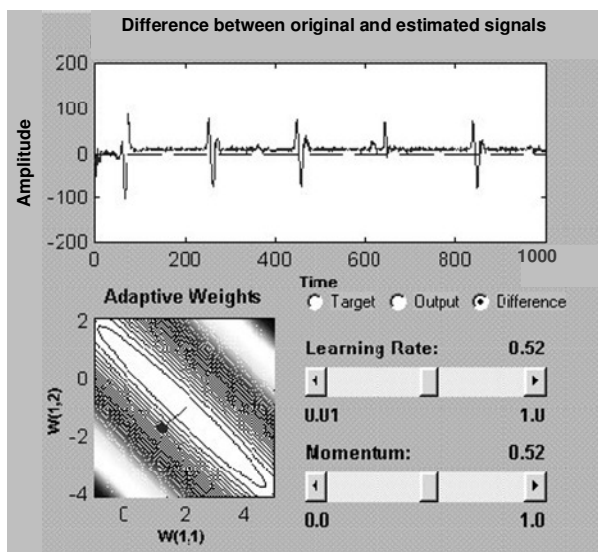

**Figure 6.** Difference signal (fetal ECG) when initial weights were moderate.

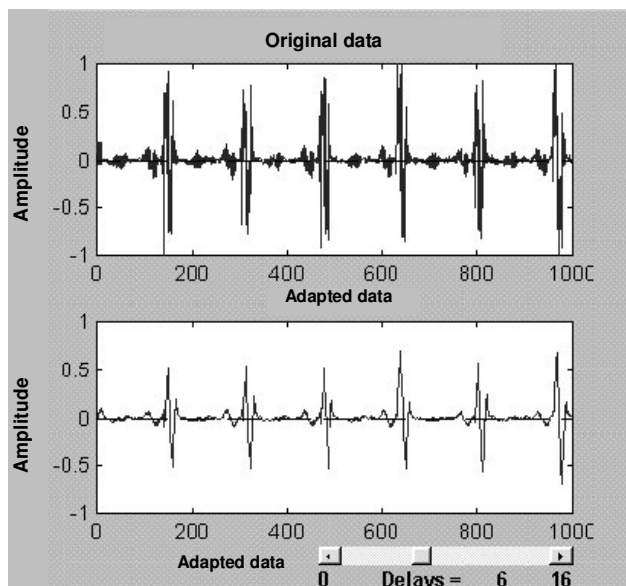

**Figure 7.** Modified signal when number of delay neuron was 6 (moderate).

needs not to be chosen like in conventional method. Currently, we are conducting further research to develop the adaptive filter, since for each signal, the right values of delay neuron number, weight, learning rate and momentum needs to be chosen

## REFERENCES

- Algunaidi MMS, Ali MAM, Islam MF (2018). Evaluation of an Improved Algorithm for Fetal QRS Detection. *Inte. J. Phys. Sci.*, 6(2): 213-220.
- Azad KAK, Darus ZM, Ali MAM (1998). Development of a Fuzzy Rule-Bae4d QRS Detection Algorithm for Fetal and Maternal Heart Rate Monitoring. *20<sup>th</sup> Annual International Conference of IEEE, Eng. Med. Bio. Society*, 20(1): 170-173.
- Costa EV, Moraes JCTB (2000). QRS Feature Discrimination Capability: Quantitative and Qualitative Analysis. *Computers in Cardiology*. pp. 399-402.
- Hasan MA, Reaz MBI, Ibrahimy MI, Hussain MS, Uddin J (2009). Detection and processing techniques of FECG signal for fetal monitoring. *Biological Procedures online*. 11(1): 263-295.
- Khamene A, Negahdaripour S (2000). A New Method for the Extraction of Fetal ECG from the Composite Abdominal Signal. *IEEE Trans. Biomed. Eng.*, 47(4): 507-516.
- Park YC, Lee KY, Youn DH, Kim NH, Park SH (1992). On Detecting the Presence of Fetal R-Wave Using the Moving Averages Magnitude Difference Algorithm. *IEEE Trans. Biomed. Eng.*, 39(8): 868-871.
- Poli R, Cagnoni S, Valli G (1995). Genetic Design of Optimum Linear and Nonlinear QRS Detectors. *IEEE Trans. Biomed. Eng.*, 42(11): 1137-1141.
- Ravindrakumar S, Raja KB (2017). Fetal ECG extraction and enhancement in prenatal monitoring — Review and implementation issues. *Trendz Inform. Sci. Comput.*, pp. 16-20.
- Rodrigues JN, Owall V, Sornmo L (2001). QRS Detection of Pacemakers in a Noisy Environment Using a Time Lagged Artificial Neural Network. *IEEE Int. Symp. Circuits Syst.*, pp. 596-599.
- Sahin I, Yilmazer N, Simaan MA (2017). A Method for Subsample Fetal H Rate Estimation under Noisy Conditions. *IEEE Trans. Biomed. Eng. Eart.*, 57(4): 875 – 883
- Widrow B, Stearns SD (1985). *Adaptive Signal Processing*. Prentice Hall, USA.
- Wenjuan J, Yang C, Zhong G, Zhou M, Wu S (2017). Fetal ECG extraction based on adaptive linear neural network. *3rd International Conference. Biomed. Eng. Inform.*, pp. 899-902.