

A New Transmit Diversity Method Using Quantized Random Phases

by

Ensieh Berenjkoub

A thesis
presented to the University of Waterloo
in fulfillment of the
thesis requirement for the degree of
Master of Applied Science
in
Electrical and Computer Engineering

Waterloo, Ontario, Canada, 2013

© Ensieh Berenjkoub 2013

I hereby declare that I am the sole author of this thesis. This is a true copy of the thesis, including any required final revisions, as accepted by my examiners.

I understand that my thesis may be made electronically available to the public.

Abstract

Wireless communication systems, aside from path-loss, also suffer from small scale up-and-down variations in the power of the received signal. These fluctuations in the received signal power, commonly referred to as multi-path fading, result in a significant performance degradation of the system. One way to combat fading is diversity. The idea behind diversity is to provide the receiver with multiple independent copies of the transmitted signal, either in time, frequency or space dimension.

In broadcast networks with underlying slow-faded channels, an appropriate option for exploiting diversity is transmit diversity, which deploys several antennas in the transmitter terminal. Based on the amount of available channel state information on the transmitter side, various transmit diversity schemes have been proposed in the literature. Because of certain limitations of broadcast networks, a practical assumption in these networks is to provide no channel state information for the transmitter.

In this dissertation, a new scheme is proposed to exploit transmit diversity for broadcast networks, assuming no channel state information in the transmitter. The main idea of our proposed method is to virtually impose time variations to the underlying slow-faded channels by multiplying quantized pseudo-random phases to data symbols before transmission. Using this method, all necessary signal processing can be transferred to the RF front-end of the transmitter, and therefore, the implementation cost is much less than that of alternative approaches.

Under the proposed method, the outage probability of the system is analyzed and the corresponding achievable diversity order is calculated. Simulation results show that the performance of our proposed scheme falls slightly below that of the optimum (Alamouti type) approach in the low outage probability region.

Acknowledgements

This dissertation would not have been possible without the guidance and the help of several individuals who in one way or another contributed and extended their valuable assistance in the preparation and completion of this study.

First and foremost, my utmost gratitude to my supervisor, Professor Amir K. Khandani, whose sincerity and supportiveness I will never forget. It is my honour to work under the supervision of such a knowledgeable and insightful professor.

I also wish to thank all Coding and Signal Transmission (CST) laboratory members. In particular, I would like to thank Ehsan Ebrahimzadeh, for sharing the ideas and invaluable assistance.

Last but not the least, I wish to express my love and gratitude to my beloved parents, and my dear husband, Mohammadreza Heidarpour; for their understanding and endless love, through the duration of my studies. I have no doubt that without their support, I could never come thus far.

To my parents,

and,

To my beloved husband.

Table of Contents

List of Figures	viii
List of Abbreviations	ix
Notation	x
1 introduction	1
2 Outage probability	3
2.1 Introduction	3
2.2 Outage probability in a two-path communication system	5
2.3 Outage Probability in MIMO systems	8
3 Spatial diversity	10
3.1 Introduction	10
3.2 Receive diversity	12
3.2.1 Maximal-ratio combining	12
3.2.2 Equal gain combining	13
3.2.3 Selection combining	13
3.3 Transmit diversity	14
3.3.1 Transmit diversity methods with full CSIT	14
3.3.2 Transmit diversity methods with partial CSIT	16

3.3.3	Transmit diversity methods with no CSIT	20
3.3.4	Space-time codes	26
4	Quantized random phase shifting	29
4.1	Introduction	29
4.2	Outage probability	31
4.3	Comparison with other methods	34
4.4	Diversity order	43
5	Conclusions and future works	46
5.1	Conclusions	46
5.2	Future works	47
	References	48

List of Figures

3.1	(a) Time-division and (b) frequency-division schemes for two transmit antennas	22
3.2	(a) Frequency-shifting and (b) time-shifting schemes for two transmit antennas	23
3.3	Randomized scheme for two transmit antennas	24
4.1	A schematic model of the proposed scheme	31
4.2	Outage probability versus transmission rate, for SNRs 0, 10, and 20 dB, and $N_{\Theta} = 2$	33
4.3	Transmission rate versus SNR, for outage probabilities 0.1, 0.01, and 0.001, and $N_{\Theta} = 2$	34
4.4	Transmission rate versus SNR, for outage probability 0.01, and $N_{\Theta} = 2, 4, 64$	35
4.5	Transmission rate versus SNR, for outage probability 0.1, and $N_{\Theta} = 2, 4, 64$	36
4.6	Transmission rate versus SNR, for outage probability 0.01, for single-antenna, Alamouti and the proposed methods	37
4.7	Transmission rate versus SNR, for outage probability 0.1, for single-antenna, Alamouti and the proposed methods	38
4.8	Outage probability versus transmission rate in SNR = 10 dB, for single-antenna, Alamouti and the proposed methods	39
4.9	Outage probability versus transmission rate in SNR = 20 dB, for single-antenna, Alamouti and the proposed methods	40
4.10	Outage probability versus transmission rate in SNR = 10 dB, for $N_{\Theta} = 1, 2$ and 64	42
4.11	Outage probability versus SNR, in $R = 1$, for single-antenna, Alamouti and the proposed methods	45

List of Abbreviations

AWGN	Additive White Gaussian Noise
MIMO	Multiple-Input Multiple-Output
MISO	Multiple-Input Single-Output
SIMO	Single-Input Multiple-Output
PSD	Power Spectral Density
SNR	Signal to Noise Ratio
SINR	Signal to Interference plus Noise Ratio
PDF	Probability Density Function
CSI	Channel State Information
CSIT	Channel State Information in the Transmitter
MRC	Maximal-Ratio Combining
EGC	Equal Gain Combining
SC	Selection Combining
OFDM	Orthogonal Frequency-Division Multiplexing

Notation

Boldface Upper-Case Letters	Matrices
Boldface Lower-Case Letters	Vectors
$ a $	Amplitude of the complex value a
$\arg(a)$	Phase of the complex value a
a^*	Conjugate of the complex value a
$\ \mathbf{a}\ $	Norm of the vector \mathbf{a}
A^T	Transpose of A
A^*	Hermitian of A
\mathbf{I}	The identity matrix
$\text{diag}(\mathbf{a})$	A diagonal matrix with diagonal equal to the vector \mathbf{a}

Chapter 1

introduction

One of the main problems in wireless communication is multi-path fading phenomenon, which causes small scale up-and-down variations in the power of the received signal, and results in a significant performance degradation of the system. One of the best techniques for solving this problem is to provide several independent versions of data symbols for the receiver, so that the receiver can recover data properly and with small error probability by combining these versions, i.e. it can exploit diversity.

Diversity can be exploited through different methods, among them is spatial diversity. Spatial diversity is exploited by settling several transmit or receive antennas, in order to receive data redundantly from independent paths. Pioneer ideas of spatial diversity suggested establishing the antennas in the receiver, to exploit receive diversity. Nevertheless, as cellular networks became more and more popular, demand for cheap and small mobile receivers led to emerge of transmit diversity, where the antennas are established in the transmitter.

In order to exploit transmit diversity, the transmitter should apply appropriate coding for data symbols, or use certain multipliers for symbols transmitted from each antenna. For this aim, the transmitter may be provided by some information about the channel state. Transmit diversity can be divided into different categories based on the amount of information provided for the transmitter.

In this dissertation, a literature review is performed on techniques exploiting spatial diversity, with emphasis on methods providing transmit diversity. Then, a new method is proposed to exploit transmit diversity, using no channel state information in the transmitter. Providing no information for the transmitter makes our suggested method an appropriate option for broadcast networks. Moreover, the introduced method has a very low complexity, as well as a near-optimal performance.

Our proposed method is studied from an information theoretic point of view. When information theoretic analysis of a communication system is desired, Shannon channel capacity [1] is often investigated. In slow-faded channels however, another measure, called outage capacity, has to be considered, as the Shannon capacity cannot explain the behaviour of these channels properly [2]. Consequently, as the underlying channel of our system is assumed to be slow-faded, the objective is to minimize the outage probability for a determined rate, or equivalently, to maximize the outage capacity for a desired amount of outage probability.

This dissertation is organized as follows. In Chapter 2, outage probability is introduced. Moreover, a review has been performed on the results of some relevant works, which will be used in analysis of the proposed method. In Chapter 3, spatial diversity techniques is overviewed. Although some receive diversity methods are also introduced, main focus of this chapter is on transmit diversity techniques. Chapter 4 is dedicated to proposing, analyzing and evaluating our new method. Finally, Chapter 5 concludes the report, and includes some suggestions for th future works.

Chapter 2

Outage probability

2.1 Introduction

The capacity of a communication channel, C , introduced by Shannon in 1948, is defined as follows [1]

$$C = \max_{p(x)} I(X, Y) \quad (2.1)$$

where $I(X, Y)$ is the mutual information between the transmitted and received signals. The maximization is taken over all possible distributions of transmitted signal. From another view, the capacity is the supremum of all achievable rates. A rate is said to be achievable, if there is a sequence of length n codes, with the property that the error probability can be arbitrarily small, as n goes to infinity [1]. The assumption of letting the block length go to infinity is not generally practical, because the larger the block length, the more the delay in the communication system, and there is usually a delay constraint in the system. This assumption can be realized in practice by considering a very long block compared to the channel's changing rate. If the tolerable delay in the system, and as a result the maximum block length, is multiple times larger than the channel changing's interval, the channel is said to be ergodic.

The Shannon channel capacity is well-defined for ergodic channels. The additive white Gaussian noise (AWGN) channels are generally ergodic. In fading wireless channels however, the ergodicity assumption may not hold, and the Shannon capacity may not explain the channel behaviour appropriately. The problem comes from the fact that, when we have a specific realization of the channel for a long period (which can last for a whole

communication interval), it is probable that the mutual information of the channel under that specific realization will fall below the transmission rate, even if, the transmission rate is below the Shannon (ergodic) capacity. As a result, for the non-ergodic channels, another measure called outage capacity is defined for characterizing the channel behaviour [2]. The outage capacity is the capacity of a channel, assuming a pre-determined outage probability is tolerable.

Suppose that $C(\mathbf{v})$ is the channel capacity as a function of channel variables vector \mathbf{v} . Then the outage probability P_{out} will be defined as follows [2].

$$P_{out} = Prob\{C(\mathbf{v}) < R\} \quad (2.2)$$

where R is the given rate. Note that the Shannon capacity is equal to the expectation of $C(\mathbf{v})$ over the channel variables vector. It also can be derived by letting the P_{out} be zero, and then computing the corresponding outage capacity.

As an example, consider a Rayleigh fading channel with the transmitted signal $x(n)$ and the received signal $y(n)$ for the n th time-slot. This system can be described by the following model

$$y(n) = hx(n) + w(n) \quad (2.3)$$

The channel coefficient h represents the Rayleigh fading effect, and is a zero-mean Gaussian random variable. The $w(n)$ is the AWGN in the n th time-slot. The coefficient h is assumed to be non-varying for all the time-slots of the transmission. Then the channel capacity, as a function of $|h|^2$, which is exponentially distributed, will be given by [2]

$$C(|h|^2) = \log(1 + |h|^2\rho) \quad (2.4)$$

where ρ is the signal-to-noise ratio (SNR). From Eq. (2.4), note that in order to have zero outage probability ($P_{out} = Prob\{\frac{1}{2} \log(1 + |h|^2\rho) < R\} = 0$), the transmission rate (R) should be equal to zero, i.e., the Shannon capacity of the channel is zero, which clarifies the limitations of the Shannon capacity to describe the behaviour of such channels.

As can be inferred from Eq. (2.2), for the calculation of outage probability, the distribution of mutual information is generally needed. Consequently, in comparison with the Shannon capacity, the derivation of outage capacity is harder. Because of this fact, the outage probability has not been derived for many cases, whereas the Shannon capacity is well defined and computed [3].

The rest of this chapter is organized as follows. Section 2.2 is dedicated to the derivation of outage probability for a system with a two-path channel. The importance of this case is due to the strong relevance to our work, which will be further clarified in next chapters. In

section 2.3, a literature review has been performed on the optimization of power allocation in the multi-input multi-output (MIMO) systems with the goal of minimizing the outage probability. The results of these works are used in analysis of the problem in hand.

2.2 Outage probability in a two-path communication system

One of the pioneer works in the area of outage probability is [3]. The authors of [3] have assumed that the link between the transmitter and the receiver is a two-path fading channel. Specifically, the signal received signal $y(t)$ is given by [3]

$$y(t) = h_1(t)x(t) + h_2(t)x(t - \delta) + w(t) \quad (2.5)$$

where $s(t)$ is the transmitted signal. $h_1(t)$ and $h_2(t)$ are the channels' coefficients, which are assumed to be two independent Gaussian random processes, with average powers σ_1^2 and σ_2^2 respectively, with the constraint that $\sigma_1^2 + \sigma_2^2 = 1$. $w(t)$ is the complex AWGN, with two-sided power spectral density (PSD) of $2N_0$, and δ is the relative delay of the second path with respect to the first one. The channel is assumed to be non-ergodic, so that the Shannon capacity will be zero. Consequently, the information theoretical analysis of such a system has been performed by finding its outage probability.

To compute the outage probability, first the mutual information between the transmitted and the received signals is derived as [3]

$$I = \int_{-W/2}^{W/2} \ln \left(1 + \frac{S_s(f)|H(f)|^2}{2N_0} \right) df \quad (2.6)$$

where W , and $S_s(f)$ are the bandwidth and the PSD of the transmitted signal respectively, and $H(f)$ is the channel frequency response, given by [3]

$$H(f) = h_1 + h_2 e^{j2\pi f\delta} \quad (2.7)$$

Accordingly, we have

$$|H(f)|^2 = r_1^2 + r_2^2 + 2r_1r_2 \cos(2\pi f\delta + \phi_1 - \phi_2) \quad (2.8)$$

where $r_1 = |h_1|$ and $r_2 = |h_2|$ are two independent Rayleigh distributed random variables. Moreover, $\phi_1 = \arg(h_1)$ and $\phi_2 = \arg(h_2)$ are two independent random variables with

uniform distribution over $[-\pi, \pi)$. By applying Eq. (2.8) in Eq. (2.6), and changing the variable f with $u = 2\pi\delta f$, we will get [3]

$$W^{-1}I = \frac{1}{2\pi\delta W} \int_{-\pi\delta W}^{\pi\delta W} \ln(1 + \rho(r_1^2 + r_2^2 + 2r_1r_2 \cos(u + \phi_1 - \phi_2))) du \quad (2.9)$$

where ρ is the SNR. If δW is a non-zero integer, then Eq. (2.9) can be expressed in the following form [3].

$$W^{-1}I = \ln\left(\frac{1 + \rho\mu + \sqrt{1 + (\rho\omega)^2 + 2\rho\mu}}{2}\right) \quad (2.10)$$

where $\mu = r_1^2 + r_2^2$, and $\omega = r_1^2 - r_2^2$. The outage probability of the system can be calculated using the distribution of I . The distribution of I , in turn, can be derived using Eq. (2.10), by first finding the joint pdf of μ and ω [3]. As r_1^2 and r_2^2 are two independent exponential distributed random variables, their joint pdf is given by

$$f_{r_1^2, r_2^2}(x_1, x_2) = f_{r_1^2}(x_1)f_{r_2^2}(x_2) = \frac{1}{\sigma_1^2\sigma_2^2} \exp\left(-\frac{x_1}{\sigma_1^2} - \frac{x_2}{\sigma_2^2}\right) \quad \text{for } x_1, x_2 \geq 0 \quad (2.11)$$

and zero elsewhere. The joint pdf of μ and ω , and consequently the outage probability of the system, is derived in [3] for both cases of $\sigma_1^2 = \sigma_2^2$ and $\sigma_1^2 \neq \sigma_2^2$, but only the first case will be explained here. By performing variable transformation over Eq. (2.11), we will get [3]

$$f_{\mu, \omega}(x_1, x_2) = \frac{1}{2\sigma_1^2\sigma_2^2} \exp\left[-x_1\left(\frac{1}{2\sigma_1^2} + \frac{1}{2\sigma_2^2}\right) - x_2\left(\frac{1}{2\sigma_1^2} - \frac{1}{2\sigma_2^2}\right)\right] \quad \text{for } 0 \leq |x_2| \leq x_1 \quad (2.12)$$

Consequently, by finding the integral of $f_{\mu, \omega}(x_1, x_2)$ over x_2 , the pdf of μ is given by [3]

$$f_{\mu}(x_1) = \frac{x_1}{\sigma_1^4} e^{-\frac{x_1}{\sigma_1^2}} \quad (2.13)$$

and the conditional pdf of ω (conditioned on μ) is as follows [3]

$$f_{\omega|\mu}(x_2|x_1) = \frac{1}{2x_1} \quad \text{for } |x_2| \leq x_1 \quad (2.14)$$

In order to find the outage probability, first the probability conditioned on μ is derived [3].

$$\begin{aligned} \text{Prob} \{W^{-1}I < R|\mu\} &= \text{Prob} \left\{ 1 + \rho\mu + \sqrt{1 + (\rho\omega)^2 + 2\rho\mu} < 2e^R|\mu \right\} \\ &= \text{Prob} \left\{ \omega^2 < \frac{(2e^R - (1 + \rho\mu))^2 - (1 + 2\rho\mu)}{\rho^2} := L|\mu \right\} \end{aligned} \quad (2.15)$$

Now note that, if $\frac{(2e^R - (1 + \rho\mu))^2 - (1 + 2\rho\mu)}{\rho^2} < 0$, then the above probability is equal to zero. Additionally, if $\mu^2 < \frac{(2e^R - (1 + \rho\mu))^2 - (1 + 2\rho\mu)}{\rho^2}$, then it will be one, as $\omega^2 \leq \mu^2$. For the other cases, the probability is computed using the conditional pdf given in Eq. (2.14). Therefore, we have [3]

$$\text{Prob} \{W^{-1}I < R|\mu\} = \begin{cases} 1 & \mu < \frac{e^R - 1}{\rho} \\ \int_{-\sqrt{L}}^{\sqrt{L}} \frac{1}{2\mu} d\gamma = \frac{\sqrt{L}}{\mu} & \frac{e^R - 1}{\rho} < \mu < \frac{2(e^R - e^{R/2})}{\rho} \\ 0 & \mu > \frac{2(e^R - e^{R/2})}{\rho} \end{cases} \quad (2.16)$$

Finally, for the outage probability, we can write [3].

$$\begin{aligned} P_{out} &= \text{Prob} \{W^{-1}I < R\} = \int \text{Prob} \{W^{-1}I < R|\mu\} f_{\mu}(\gamma) d\gamma \\ &= \int_0^{\frac{e^R - 1}{\rho}} f_{\mu}(\gamma) d\gamma + \int_{\frac{e^R - 1}{\rho}}^{\frac{2(e^R - e^{R/2})}{\rho}} \frac{\sqrt{L}}{\gamma} f_{\mu}(\gamma) d\gamma \\ &= 1 - \left(1 + \frac{e^R - 1}{\rho\sigma_1^2} \right) e^{-\frac{e^R - 1}{\rho\sigma_1^2}} + \left(\frac{1}{\rho\sigma_1^2} \right)^2 e^{-\frac{2(e^R - e^{R/2})}{\rho\sigma_1^2}} \int_0^{(e^{R/2} - 1)^2} \sqrt{\gamma(\gamma + 4e^{R/2})} e^{\frac{\gamma}{\rho\sigma_1^2}} d\gamma \end{aligned} \quad (2.17)$$

As it can be inferred from Eq. (2.17), the outage probability of this system does not have a closed form. The simulation results of [3] illustrate that given reasonably small outage probabilities, the outage capacity of a two-ray propagation channel is higher than that of a one-ray scenario. This improvement in the performance is due to harvesting the multi-path diversity. On the other hand, simulation results show that for large outage probabilities, the one-ray channel outperforms the two-ray propagation link. However, considering that commonly small outage probabilities are of interest, the two-ray propagation case performs better than the one-ray one [3].

2.3 Outage Probability in MIMO systems

In 1999, Telatar [4] proposed the optimal choice of power allocation among the transmit antennas in multiple-input multiple-output (MIMO) systems, in order to either maximize the Shannon capacity, or to minimize the outage probability in different scenarios. The underlying channels are assumed to be independent Rayleigh fading, and the transmitter is assumed to be unaware of channel coefficients. Let's consider a case in which channel coefficients are constant. As a result, the power allocation problem is built upon the minimization of outage probability. In particular, for the special scenario of the single-input multiple-output (SIMO), applying the obvious choice for the power (i.e. using the whole power P in the single transmit antenna), will result in the following outage probability [4].

$$P_{out} = \text{Prob} \{ \log(1 + \rho \mathbf{h}^* \mathbf{h}) < R \} = \frac{\gamma(N_r, (e^R - 1)/\rho)}{\Gamma(N_r)} \quad (2.18)$$

where R is the desired rate, \mathbf{h} is the $N_r \times 1$ channel coefficient vector, and N_r is the number of receive antennas. Also, $\rho = \frac{P}{N_0}$ is the SNR, where N_0 is the AWGN power. Moreover, $\Gamma(\cdot)$ and $\gamma(\cdot, \cdot)$ are the gamma and incomplete gamma functions respectively.

On the other hand, for the general MIMO case, Telatar [4] conjectured that the optimal power allocation is to select a fraction of transmit antennas and divide the power equally among them. It means that the optimal covariance of the transmitted signal has the following form.

$$\mathbf{Q}_{opt} = \frac{P}{k} \text{diag}(\overbrace{1, \dots, 1}^{k \text{ ones}}, \overbrace{0, \dots, 0}^{N_t - k \text{ zeroes}}) \quad (2.19)$$

for some $k \in \{1, 2, \dots, N_t\}$, where the N_t is the number of transmit antennas. Additionally, he said that, the higher the transmission rate, the smaller the optimum k . The latter part of the conjecture comes from the fact that as k increases, the expectation of capacity also increases, but the tail of its distribution decays faster. As a result, if a rate greater than the average capacity is desired (leading to a quite large outage probability which is not usually of interest) a small k has to be chosen. Several simulations have been performed in [4], which are in agreement with his conjecture. The simulations show that for small outage probabilities, always the best choice is to use all the transmit antennas. For the MISO case (one receive antenna), using all the transmit antennas will result in the following outage probability [4].

$$P_{out} = \frac{\gamma(N_t, N_t(e^R - 1)/\rho)}{\Gamma(N_t)} \quad (2.20)$$

In 2007, the Telatar conjecture was proved for the MISO systems in [5]. Moreover, it is proved that for the case of

$$\text{SNR} > 2^R - 1 \quad (2.21)$$

the optimal strategy is to use all the antennas. Additionally, for the case of

$$0 < \text{SNR} < \frac{2(2^R - 1)}{-2L_w(-1, -\frac{1}{2}e^{-\frac{1}{2}}) - 1} \quad (2.22)$$

only one antenna has to be used to obtain minimum outage probability [5]. $L_w(\cdot)$ is the LAMBERT W function, which is the inverse of the function $f(W) = W \exp(W)$. In an independent work in [6] also, the conjecture is proved for the MISO systems.

Chapter 3

Spatial diversity

3.1 Introduction

In a wireless channel, because of the multi-path fading phenomenon, it is probable that the received signal is so poor that data cannot be recovered by the receiver. One possible way to address this issue is to provide several versions of the signal for the receiver, hoping that their combination is strong enough to allow proper data recovery. This method is called diversity, which is one of the most important methods of solving the problems caused by fading in wireless communications.

There are different techniques to exploit diversity in a point-to-point communication system, based on whether temporal, frequency, or spatial diversity is exploited [7].

- Temporal diversity: This type of diversity is made by proper channel coding in combination with time interleaving. Channel coding generates redundancy in data, and time interleaving spreads the redundant bits over time, so that they will experience different channel situations, as the channel varies over the time. As a result, the receiver can exploit diversity. Note that time interleaving is limited to the tolerable delay in the system, so temporal diversity can be achieved only if the channel variation is fast enough to have almost independent channel realizations in the tolerable delay interval. If the channel is almost constant in this interval, we cannot have different versions of data using this technique.
- Frequency diversity: This technique is a dual of the time diversity method, in the frequency domain. Generally, because of the so-called frequency selectivity phenomenon, signals experience different channel behaviours in different frequencies. As

a result, if an appropriate channel code is applied to generate redundancy, by splitting the redundant bits over different frequency sub-bands, the receiver can exploit frequency diversity. Note that if channel fading is frequency selective in the frequency band used, this technique is beneficial. However, if the channel is almost flat over the band, the receiver cannot exploit diversity using this method.

- **Spatial diversity:** In this method, several transmit or receive antennas, with separate locations or polarizations, send redundant data, or receive the same signal, independently. This method is studied in more detail in this chapter.

In slow fading channels, time diversity forces a large delay. Similarly, frequency diversity causes a waste of spectrum in channels with a small delay spread. Consequently, these two techniques are not suitable in many cases [7]. It is interesting that from this point of view, fast fading and frequency selective fading are beneficial phenomena rather than destructive ones, because they give us randomization, which leads to achieving diversity [8]. Spatial diversity can be used efficiently in most scenarios, unless several antennas cannot be settled far enough apart from one another.

In addition to the above methods, in a network with several users, such as downlink of cellular networks, multi-user diversity can be exploited as well [8]. In these networks, there is one transmitter (base station) and several receivers (users), and in each time-slot, the transmitter decides to send data to one of the users. One way of achieving multi-user diversity in such networks is to make this decision based on users' channel situation in each time-slot. By using this method in a network with a sufficiently large number of users, fading channel with independent channels for different users has a better sum capacity than the AWGN channel with the same average SNR [8]. This improvement results from the fact that it is very probable that at least the instantaneous SNR of one of the users' channel is better than the average SNR (corresponding AWGN channel).

The rest of this chapter is organized as follows. In section 3.2 some of the receive diversity techniques are introduced. In particular, maximal-ratio combining, equal-gain combining, and selection combining methods are described. The main part of this chapter is dedicated to transmit diversity, which is proposed in section 3.3. In this section, different transmit diversity techniques are described through three main categories, based on the channel information available on the transmitter side.

3.2 Receive diversity

When several replicas of a symbol are delivered to the receiver side via several receive antennas, they should be combined in a proper way, in order to have a better performance than the single-antenna receiver. There are different methods of combination, which are introduced in this section.

Before moving on to explain the different methods in detail, diversity order must be introduced, as one of the measures for determining how much a diversity scheme can improve the reliability of a system. In fact, diversity order is the number of independent paths established between the transmitter and the receiver. Accordingly, in a simple one-path system, the average error probability decreases proportional to the inverse of SNR ($\frac{1}{\text{SNR}}$). If the average error probability can decrease proportional to $\frac{1}{\text{SNR}^d}$ in a system, that system has a maximal diversity order of d . To be more exact, diversity order in a system with the error probability P_e and SNR ρ is defined as follows [9]

$$d = - \lim_{\rho \rightarrow \infty} \frac{\log P_e(\rho)}{\log \rho} \quad (3.1)$$

In a system with N_t transmit antennas and N_r receive antennas, the maximal diversity order is equal to $N_t \times N_r$ [9].

3.2.1 Maximal-ratio combining

One of the combining methods in the receiver side is maximal-ratio combining (MRC), which is optimal in the absence of interference [10]. Note that the optimality holds for all the channel fading models, leading to a diversity order of N_r , when N_r receive antennas are established. The main idea is to multiply the received signal from each path to the conjugate of its channel coefficient. Suppose we have a two-receive antenna system with a Rayleigh fading channel, with the transmitted signal x , and received signals y_1 and y_2 as follows [11]

$$\begin{aligned} y_1 &= h_1 x + w_1 \\ y_2 &= h_2 x + w_2 \end{aligned} \quad (3.2)$$

where $h_1 = r_1 e^{j\phi_1}$ and $h_2 = r_2 e^{j\phi_2}$ are two independent Gaussian random variables, representing channels coefficients, and w_1 and w_2 represent the AWGN for the corresponding

channels. MRC method combines the two received signals as in the following [11].

$$\tilde{x}_{MRC} = h_1^* y_1 + h_2^* y_2 \quad (3.3)$$

By substituting Eq. (3.2) into Eq. (3.3), we get

$$\tilde{x}_{MRC} = (r_1^2 + r_2^2)x + h_1^* w_1 + h_2^* w_2 \quad (3.4)$$

Although MRC method is optimal, other combining methods are preferred in some scenarios, because MRC scheme needs full CSI in the receiver (for all the paths), leading to a high complexity. Specifically, the method cannot be used for non-coherent schemes, as it needs information about the channel phases [10].

3.2.2 Equal gain combining

As mentioned in section 3.2.1, although MRC is optimal, some other combining methods may be preferred, because of MRC's complexity. One of these sub-optimal methods is equal gain combining (EGC). In this method, the received signals are multiplied in the conjugate of their corresponding channel phases, and then they are added [10]. For the case of two paths, the combination will be as follows, assuming that the received signals are as in Eq. (3.2).

$$\tilde{x}_{EGC} = y_1 e^{-j\phi_1} + y_2 e^{-j\phi_2} = (r_1 + r_2)x + w_1 e^{-j\phi_1} + w_2 e^{-j\phi_2} \quad (3.5)$$

The complexity of EGC is less than that of MRC, as it does not require the information of channel coefficient amplitudes, but this method, similar to MRC, can only be applied to coherent schemes, where exact information on channel phases is not available [10].

3.2.3 Selection combining

Selection combining (SC) method does not need CSI about all the paths, and can be applied for non-coherent schemes, as it chooses only one of the received signals, and does not combine all the signals [10]. The method of choosing can be varied, but the conventional form is to choose the path with the largest instantaneous SNR value. Another way, which is simpler as tracking all the paths' SNRs are not required, is to choose one branch and use it for data extraction, as long as its SNR is above a pre-determined threshold [10].

The SC method is the simplest method of all, but uses only one of the received signals, so that the diversity cannot be exploited properly. Some hybrid methods are proposed that suggest some trade off between the amount of CSI needed and how diversity is achieved [10].

3.3 Transmit diversity

In many communication systems, such as cellular networks, the receive diversity cannot be exploited, as the mobile receivers should have small size and low cost [11]. The idea of transmit diversity is proposed to address this issue. This idea suggest establishing the antennas on the base stations (transmitters of downlink communication), instead of mobile receivers. In the design of base stations, in contrast to that of mobile receivers, cost and complexity issues are not very important. Moreover, settling several antennas in one base station, eliminates the need to establish several antennas in many mobile receivers [11].

Transmit diversity methods can generally be categorized in three main groups [7].

- Feedback methods: In these methods, the receiver sends full or partial channel information to the transmitter, so that the antennas can be configured properly. Information may be received explicitly or implicitly in the transmitter. As a result, these methods assume full/partial Channel State Information (CSI) in the transmitter.
- Feedforward or training methods: In these methods, no feedback is sent from the receiver side. Instead, the transmitter uses feedforward or training methods to estimate the CSI.
- Blind methods: In these methods, the transmitter has no CSI, and chooses the necessary parameters in a blind manner.

In the following of this section, a literature review is performed on the methods that use full, partial, and no CSI in the transmitter (CSIT).

3.3.1 Transmit diversity methods with full CSIT

One of the pioneer ideas in the transmit diversity area is to let the transmitter be informed about the channel state, through feedback from the receiver side. Then, based on this information, it chooses some multipliers, and multiplies them to the symbols, before sending them via the antennas. In fact, the idea can be viewed as a version of MRC, discussed in section 3.2.1, adapted for the transmitter side.

Suppose there are N_t transmit antennas and one receive antenna in the system, and the transmitter has been provided by full CSI. Thus, in every interval, first a training sequence or pilot signal is sent to the receiver via all the transmit antennas. Then, the receiver derives the channel coefficients' amplitudes and phases, for all of the N_t channels,

and sends them to the transmitter. Based on this information, the transmitter chooses the multipliers.

Suppose the channel amplitude and phase between the n th antenna, $n = 1, 2, \dots, N_t$, and the receiver, are $|h_n|$ and $\arg(h_n)$, respectively. The strategy is to multiply the transmitting symbol by $\alpha_n e^{j\theta_n}$ before sending it via the n th antenna, where [8]

$$\begin{aligned}\alpha_n &= \frac{|h_n|^2}{\sum_{i=1}^k |h_i|^2} & \text{for } n = 1, 2, \dots, N_t \\ \theta_n &= -\arg(h_n) & \text{for } n = 1, 2, \dots, N_t\end{aligned}\tag{3.6}$$

This method is called beam-forming. Now suppose the receiver has more than one (say N_r) antennas. In this case, there are $N_t N_r$ channels between the transmitter and the receiver. Suppose the $N_r \times N_t$ matrix \mathbf{H} is the channel matrix. Then, the system model can be expressed by [12]

$$\mathbf{y} = \mathbf{H}\mathbf{x} + \mathbf{w}\tag{3.7}$$

where \mathbf{x} is the $N_t \times 1$ transmitted vector, \mathbf{y} is the $N_r \times 1$ received vector, and \mathbf{w} is the $N_r \times 1$ AWGN vector. Using singular value decomposition, the channel matrix can be expressed by $\mathbf{H} = \mathbf{U}\mathbf{\Lambda}\mathbf{V}^*$, where \mathbf{U} and \mathbf{V} are two unitary matrices, and $\mathbf{\Lambda}$ is a diagonal matrix containing the singular values of \mathbf{H} . Assuming that the transmitter has full CSI, beam-forming is performed by multiplying matrix \mathbf{V} to the transmitting vector \mathbf{x} , before transmission, i.e. $\hat{\mathbf{x}} = \mathbf{V}\mathbf{x}$ is sent [12]. As a result, Eq. (3.7) is modified as the following equation.

$$\mathbf{y} = \mathbf{H}\hat{\mathbf{x}} + \mathbf{w} = \mathbf{U}\mathbf{\Lambda}\mathbf{V}^*\mathbf{V}\mathbf{x} + \mathbf{w} = \mathbf{U}\mathbf{\Lambda}\mathbf{x} + \mathbf{w}\tag{3.8}$$

where the last equality comes from the assumption that \mathbf{V} is a unitary matrix, i.e. $\mathbf{V}^*\mathbf{V} = \mathbf{I}$. In the receiver side, matrix \mathbf{U}^* is multiplied to the received signal \mathbf{y} , to get the following signal [12]

$$\hat{\mathbf{y}} = \mathbf{U}^*\mathbf{y} = \mathbf{U}^*\mathbf{U}\mathbf{\Lambda}\mathbf{x} + \mathbf{U}^*\mathbf{w} = \mathbf{\Lambda}\mathbf{x} + \mathbf{U}^*\mathbf{w}\tag{3.9}$$

where the last equation is obtained using Eq. (3.8), and the fact that $\mathbf{U}^*\mathbf{U} = \mathbf{I}$. By this method, the transmitted vector entries become disjoint in the receiver, as can be inferred from Eq. (3.9). Consequently, if redundant symbols are transmitted, disjoint versions of them are received, so diversity can be exploited.

3.3.2 Transmit diversity methods with partial CSIT

This section, introduces some work that assumes that partial CSI is available in the transmitter. These works, on one hand, deal with a multi-cast scenario, where multi-user diversity can be exploited. Providing CSI for the transmitter is crucial to exploiting this type of diversity, as the user selection method has to be based on certain information (as opposed to being completely random), to harvest diversity gain in the system [8]. On the other hand, the assumption of providing full CSIT is unrealistic, especially for large networks. Consequently, the idea of providing partial CSI for the transmitter is proposed.

One of the pioneer works in this area is [8], where the concept of opportunistic beam-forming is introduced. Generally, in order to exploit complete multi-user diversity in a network, the receivers have to send their instantaneous channel situation to the transmitter (full CSIT), and there should be a scheduling mechanism in the transmitter side. Moreover, the transmitter must be able to set the transmission rate based on the channel situation of the desired receiver.

The opportunistic beam-forming method, proposed to release the strong assumption of full CSIT, combines the random selection of multipliers in the transmit antennas, with wise selection of the user to send data based on partial CSIT [8]. Suppose that the transmitter wants to send data to the k th user, in the t th time-slot. The transmitter uses N_t antennas to transmit the same data over them, with different multipliers. At the n th antenna, the pre-determined complex value $\sqrt{a_n(t)}e^{j\theta_n(t)}$ is multiplied to the transmitting signal, and then the signal is sent. The complex multipliers are chosen in such a way that $\sum_{n=1}^{N_t} a_n(t) = 1$ holds. As a result, the following signal is received by the receiver side [8].

$$y_k(t) = \left(\sum_{n=1}^{N_t} \sqrt{a_n(t)} e^{j\theta_n(t)} h_{n,k}(t) \right) x(t) + z_k(t) \quad (3.10)$$

where $h_{n,k}(t)$ is the channel coefficient between the n th transmit antenna and the k th user in t th time-slot. Eq. (3.10) is equivalent to transmission using one transmit antenna to the k th user, through a channel with the following coefficient [8].

$$h_k(t) = \sum_{n=1}^{N_t} \sqrt{a_n(t)} e^{j\theta_n(t)} h_{n,k}(t) \quad (3.11)$$

If the complex multipliers in the transmitter side vary with time, $h_k(t)$ will be a time-variant variable, even if $h_{n,k}$ s are constant over time. Consequently, we will have a forced fast-faded channel, which is preferred for diversity exploitation [8].

Based on Eq. (3.6), the optimal choice for the multipliers in the transmitter in t th time-slot is given by [8]

$$a_n(t) = \frac{|h_{n,k}|^2}{\sum_{i=1}^{N_t} |h_{i,k}|^2} \quad , \quad \theta_n(t) = -\arg(h_{n,k}) \quad \text{for } n = 1, 2, \dots, N_t \quad (3.12)$$

However, using these optimal values in reality may be infeasible, as the transmitter needs to be informed about all the coefficients' magnitudes and phases of the N_t channels between the N_t transmit antennas and the receive antenna, i.e. $2N_t$ values for each user. In other words, the transmitter needs full CSI in order to compute these optimal multipliers [8].

In fact, the idea of opportunistic beam-forming tries to solve this problem, by choosing the multipliers in a random manner, instead of using the optimal values. To be more precise, the transmitter chooses the multipliers' phases and magnitudes, $a_n(t)$ and $\theta_n(t)$ pseudo-randomly, and transmits data to the user with the highest SNR in each time interval, as before. As a result, instead of $2N_t$ values, the users are only supposed to measure and send the amount of $\text{SNR}_k = \frac{|h_k(t)|^2}{\sigma^2}$ to the transmitter in the t th time-slot, where σ^2 is the AWGN power, and the length of the interval t is a design parameter. In every interval, after receiving the feedback information from all the users, the transmitter chooses the user with the highest SNR value for sending data [8]. It has been proved that the performance of this method converges to that of the optimal one as the number of users increases [8].

In deploying this method, we face to two main problems [8]. The first arises because in reality, different users experience different channel situations, due to various aspects, such as how far they are from the transmitter, how scattering their environment is, their mobility, and so on. As a result, fairness cannot be achieved using this method. The second occurs because this method can perform at near optimal point, but only over a long enough time interval. However, in many applications, the average long-term performance is not very important because of the delay limitations. To handle these problems, several scheduling methods have been proposed, including the proportional fairness algorithm. These scheduling methods are combined with the opportunistic beam-forming technique in order to obtain a fair and near optimal method, with reasonable delay and partial CSIT. It is claimed [8] that the opportunistic beam-forming method in conjunction with scheduling can surpass space-time codes. Moreover, unlike the space-time codes, using this method, receivers do not need to be informed about the method, or change their structure [8]. However, it must be noted that space-time codes have the benefit of requiring no CSIT, unlike opportunistic beam-forming.

In [12], a method similar to opportunistic beam-forming is proposed, assuming more than one receive antenna in general. The method is based on the eigen beam-forming,

explained in section 3.3.1, but uses a random beam-forming matrix in the transmitter.

Suppose the singular value decomposition is performed on the channel coefficient matrix between the transmitter and the k th receiver, \mathbf{H}_k , resulting in $\mathbf{H}_k = \mathbf{U}_k \mathbf{\Lambda}_k \mathbf{V}_k^*$, where \mathbf{U}_k and \mathbf{V}_k are two unitary matrices and $\mathbf{\Lambda}_k$ is a diagonal matrix containing the singular values of \mathbf{H}_k . As explained in section 3.3.1, in the eigen beam-forming method, \mathbf{V}_k has to be multiplied to the signal vector \mathbf{x} . This method is limited to cases where full CSIT is available. In the method proposed in [12], instead, a random unitary matrix (say \mathbf{V}'_k) is multiplied to the signal in the transmitter. In the receiver side, the matrix \mathbf{U}_k^* is multiplied to the received signal \mathbf{y}_k , similar to when using eigen beam-forming, to get $\hat{\mathbf{y}}_k = \mathbf{\Lambda}_k \mathbf{V}_k^* \mathbf{V}'_k \mathbf{x} + \mathbf{U}_k^* \mathbf{w}$.

In order to choose the user for transmitting data, the effective SNR is sent from the users to the transmitter in each time interval. Based on this information, and using proportional fairness algorithm, the transmitter decides on the desired user. As illustrated in [12], the performance of this method converges to that of the eigen beam-forming method, when the number of users increases.

In [14], a method similar to that in [8] is proposed. The main difference is that N_t different symbols $\{d_n\}_{n=1}^{N_t}$ are sent over N_t transmit antennas for N_t selected users, as opposed to the proposed scheme in [8], where only one user is selected and the same data is sent over all the transmit antennas. Before transmission, N_t random $N_t \times 1$ vectors, ϕ_n $n = 1, 2, \dots, N_t$, are chosen and multiplied to the transmitting symbols, so the $N_t \times 1$ transmitted vector $\mathbf{x}(t)$ will be as in the following [14].

$$\mathbf{x}(t) = \sum_{n=1}^{N_t} \phi_n(t) d_n(t) \quad (3.13)$$

The k th user receives the signal $y_k(t)$ as follows.

$$y_k(t) = \mathbf{h}_k^T \mathbf{x}(t) + w(t) = \sum_{n=1}^{N_t} \mathbf{h}_k^T \phi_n(t) d_n(t) + w(t) \quad (3.14)$$

where \mathbf{h}_k is the $N_t \times 1$ channel vector between the transmitter and the k th user, and $w(t)$ is the AWGN. In the receiver side, N_t values for the signal-to-interference-plus-noise ratio (SINR) can be computed for the N_t channels between the transmitter and the k th user. For computing the n th value, it is assumed that d_n is the desired symbol, and all other symbols are treated as interference.

$$\text{SINR}_{k,n} = \frac{|\mathbf{h}_k^T \phi_n|^2}{\rho^{-1} + \sum_{i \neq n} |\mathbf{h}_k^T \phi_i|^2} \quad n = 1, 2, \dots, N_t \quad (3.15)$$

where ρ is the average SNR, and assumed to be equal for all users. The users will then select their largest SINR and send it along with its index to the transmitter. Suppose that for the k th user, $\max_{1 \leq n \leq N} \text{SINR}_{k,n} = \text{SINR}_{k,n_0}$ in time-slot t . Then, this user will send the value of SINR_{k,n_0} and the index of n_0 to the transmitter. At the transmitter side, after receiving feedback from the users, each symbol is dedicated to the user with the largest value of SINR for that beam, i.e., d_n is dedicated to the k_0 th user, if $\max_{1 \leq k \leq K} \text{SINR}_{k,n} = \text{SINR}_{k_0,n}$ holds, where K is the number of users in the system. Note that only a subset of users have sent their SINR values for any of the beams, as they only send it if it is their maximal value of SINR. For those who have not sent their SINR value of the n th beam, this value is assumed to be zero on the transmitter side.

The authors of [15] have adopted the method introduced in [14] for sparse networks. In [14] it is assumed that the number of users is several times larger than the number of transmit antennas, N_t . However, the network is assumed to be sparse in [15], so this assumption does not hold. Considering sparse networks, transmitting N_t different symbols will not necessarily be optimal, so it is assumed that a subset of N_t beams are deployed in the transmitter, i.e. B data symbols are sent to B selected users, where $1 \leq B \leq N_t$. The value of B is considered as a design parameter, and some efforts have been made to find its optimal value for different scenarios [15]. Moreover, it has been shown that there is no need to send the accurate value of SINR to the transmitter, and even its two-bit quantized version is almost sufficient for exploiting multiuser diversity.

Although using random beam-forming, as in [8] and [14], can result in a near optimal performance in a network with a large number of users, the performance will degrade dramatically if the number of users is decreased [16]. On the other hand, it is very probable to have a sparse network in practice, because in data-access networks, the traffic is usually bursty, and consequently, intervals with a small number of users are very likely. As a result, in [16], after choosing a subset of users to send data to according to their average SINRs (similar to the methods proposed in [8] and [14]), different strategies have been introduced for getting more feedback from this subset, so that more accurate beam-forming is possible and performance degradation due to random beam-forming is avoided.

The authors of [17] have deployed the idea of opportunistic beam-forming in a system using OFDM signals, to improve the performance of users with channels under both slow and flat fading. The idea is to exploit multi-user diversity in frequency as well as in time. To do so, each user sends feedback containing the information of all its sub-channels. This information is used to choose the best sub-band on which to send data to each user, so that diversity can be achieved in the frequency domain as well. The main problem of this method is the resulting heavy feedback overhead. This problem is addressed by considering two facts and using them to reduce the required feedback. The first is that the adjacent

sub-carriers are highly correlated. The second is that the most important part of the feedback is the information about the strongest sub-channel. Additionally, it has been suggested that using adoptive feedback would help to decrease the amount of required feedback [17].

In [18] three methods are compared in terms of network throughput. The first method is the opportunistic beam-forming proposed in [8]. The second, called co-phasing, is to do the same as in the first method, but the beam-forming multipliers are only random in terms of phase, and their amplitudes remain constant and equal. The third is to choose one of the transmit antennas randomly in each interval and send data only via that antenna. It is shown that if the number of transmit antennas is large, then the performance of the opportunistic beam-forming and co-phasing techniques is the same as that for single-antenna receivers [18].

3.3.3 Transmit diversity methods with no CSIT

Transmit diversity methods using no CSIT are divided into two main categories. The first generally adds some kind of randomness to the system in order to exploit diversity in a slow (or flat) faded channel. In other words, the methods of this category mainly try to generate forced fast (frequency selective) fading. The second is space-time codes. This section is dedicated to explaining some of the methods of the first category, while space-time codes will be introduced in section 3.3.4.

One of the pioneer works in the transmit diversity area, using no CSIT, is [13], where a method called phase sweeping is introduced. In this method, the transmitter uses two antennas to send the same data. Before modulating the data signal with the carrier signal, the carrier will be phase modulated in one of the antennas. In the other one, the carrier is used normally. Using this method, the two channels involved will become de-correlated in the space domain.

A combination of this method and bit interleaving technique is suggested in [13]. Moreover, by using the same idea in the receiver instead of the transmitter, a comparison is performed between this method and MRC and SC methods, introduced in sections 3.2.1 and 3.2.3, respectively. It is shown that if the proposed method is used without interleaving, its performance is worse than that of those two techniques. However, a combination with bit interleaving will result in a better performance when very small error probability is desired.

In 1999, Narula [19] analyzed and compared different transmit diversity schemes from an information theoretic perspective, assuming no CSI in the transmitter and a slow-faded channel between the transmitter and the receiver. The schemes are classified into two main

categories: vector coding and scalar coding. In vector coding schemes, a vector of symbols is transmitted from the transmit antennas. In fact, each antenna sends a different symbol in general. In contrast, in scalar coding schemes, all the transmit antennas send the same symbol, usually to avoid complexity. It is obvious that by forcing this limitation on the system, the scalar coding schemes will be sub-optimal in general. In [19], the main focus is on the scalar coding schemes, and their mutual information is computed, considering a general block-fading channel.

Before analyzing different methods, a formal definition for mutual information is included in [19], as follows [19]

$$I = \frac{1}{M} \lim_{M \rightarrow \infty} I_M \quad (3.16)$$

where I_M is the mutual information between inputs and outputs for a block of length M . Considering this definition, several different scalar-coded schemes are studied in [19], as explained next. For all of the schemes, it is assumed that we have N_t transmit antennas and the channel coefficient between the n th antenna and the receiver is h_n . Additionally, the norm of the channel coefficient vector is defined as $\|\mathbf{h}\| = \sqrt{|h_1|^2 + |h_2|^2 + \dots + |h_{N_t}|^2}$.

Time- and frequency-division systems

In a time-division method, data is transmitted from one of the transmit antennas, in a round robin order. As the antennas are assumed to be independent, a set of parallel channels is established, using this method. For example, for the case of $N_t = 2$, as depicted in Fig. 3.1-a, the symbol x_k is sent from the first antenna in time-slot k , if k is odd, and from the second antenna if k is even [19]. In fact, this method converts spatial diversity to time diversity. The mutual information of such a system can be derived as [19]

$$I_{TD} = \frac{1}{N_t} \sum_{n=1}^{N_t} \log(1 + \rho |h_n|^2) \quad (3.17)$$

where ρ is the average SNR. On a similar basis, frequency-division method converts the spatial diversity to the frequency diversity, by using different bands for the adjacent symbols. Fig. 3.1-b shows the method for a two antenna case. In this method, the mutual information is the same as in Eq. (3.17), revealing the duality of time-division and frequency-division methods [19]. It is claimed in [19] that many other methods, resulting in orthogonal signals, have the same behaviour as time- and frequency-division methods. Moreover, it has been shown that only in the special case of exactly the same coefficients in the two channels, will this method's performance be similar to that of optimal vector-coded methods.

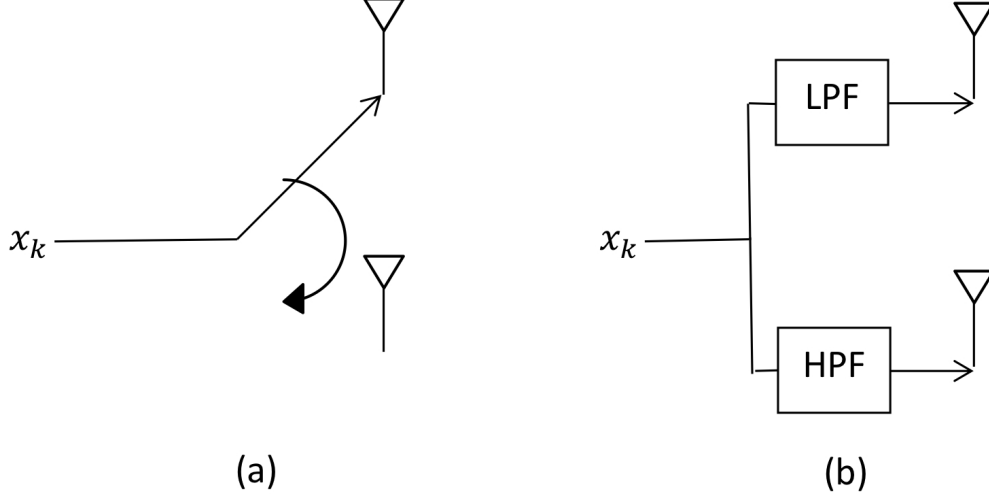

Figure 3.1: (a) Time-division and (b) frequency-division schemes for two transmit antennas

Time- and frequency-shifting systems

The idea of frequency shifting scheme was first introduced in [13], but it has been analyzed in [19] with an information theoretical approach. Suppose we want to transmit the symbol x_k in the k th time slot. For transmitting this symbol from the n th antenna, where $n = 1, 2, \dots, N_t$, its frequency shifted version, $e^{j\pi\delta(n-1)k}x_k$, will be transmitted, where δ is a system parameter. Fig. 3.2-a shows the scheme for two transmit antennas.

Using this method, the mutual information for a block with length M is given by [19]

$$I_M = \sum_{k=1}^M \log \left(1 + \rho \left| \frac{1}{\sqrt{N_t}} \sum_{n=1}^{N_t} e^{j\pi\delta(n-1)k} h_n x_k \right|^2 \right) \quad (3.18)$$

When the block size (M) goes to infinity, assuming that the parameter δ is irrational, the mutual information will be as follows [19]

$$I = \frac{1}{2\pi} \int_{-\pi}^{\pi} \log \left(1 + \frac{\rho}{N_t} \left| \sum_{n=1}^{N_t} e^{j(n-1)\omega} h_n \right|^2 \right) d\omega \quad (3.19)$$

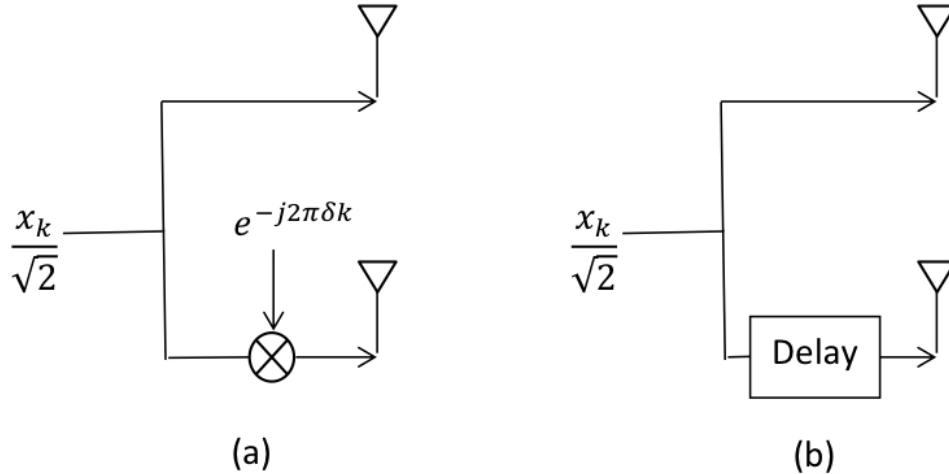

Figure 3.2: (a) Frequency-shifting and (b) time-shifting schemes for two transmit antennas

Time-shifting scheme, depicted in Fig. 3.2-b for a two transmit antenna case, is a dual of frequency-shifting scheme. The main idea of this scheme is to add various delays to the transmitting symbol in different antennas, before transmission. In the n th antenna, a $(n - 1)$ -step delay is added to the symbol. It can be shown that the mutual information of this method is the same as that in Eq. (3.19) [19]. The performance of time- and frequency-shifting schemes are similar to that of vector-coded systems, but only if at most one of the channel coefficients is non-zero [19].

Randomized scheme

Randomized scheme is proposed in [19], aiming to obtain a scalar-coded scheme with the property that its mutual information depends only on the channel coefficient vector norm ($\|\mathbf{h}\|$). The main idea is to multiply a random complex value to the transmitting symbol, before sending it from each transmit antenna. The scheme is depicted in Fig. 3.3 for a two transmit antenna case.

In this scheme, a random vector β_k is generated uniformly over the N -dimensional complex unit sphere [19]. Then, this random vector is multiplied to the symbol to be sent, i.e., $\beta_{n,k}x_k$ is sent through the n th antenna, in the k th time-slot. Accordingly, the received signal will be [19]

$$y_k = \mathbf{h}^T \beta_k x_k + w_k \quad (3.20)$$

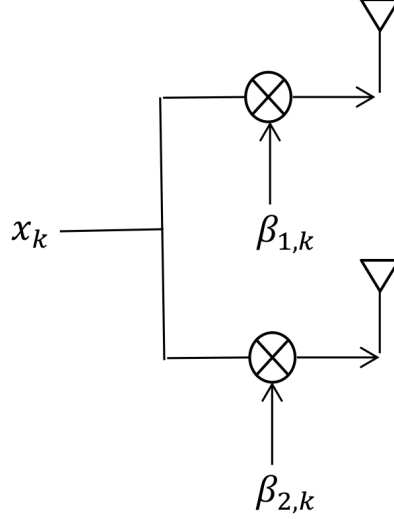

Figure 3.3: Randomized scheme for two transmit antennas

where y_k is the received signal, and w_k is the AWGN in the k th time-slot. Random vector $\boldsymbol{\beta}$ is now defined in the following way

$$\boldsymbol{\beta}_k = \mathbf{U}_k [1 \ 0 \ \dots \ 0]^T \quad (3.21)$$

where \mathbf{U}_k is a random unitary matrix with the property that for any unitary matrix \mathbf{U} , both $\mathbf{U}\mathbf{U}_k$ and $\mathbf{U}_k\mathbf{U}$ have the same distribution as \mathbf{U}_k (\mathbf{U}_k is drawn from the so-called circular unitary ensemble). One example of a random vector with this property is a vector of normalized Gaussian variables [19], i.e.

$$\beta_{n,k} = \frac{G_{n,k}}{\sqrt{\sum_{i=1}^{N_t} |G_{i,k}|^2}} \quad \text{for } n = 1, 2, \dots, N_t \quad (3.22)$$

where $G_{n,k}$ s, $n = 1, 2, \dots, N_t$, are independent, identically-distributed Gaussian random variables. Now, the channel coefficient vector is expressed as follows

$$\mathbf{h} = \mathbf{U}'^T(\mathbf{h}) [||\mathbf{h}|| \ 0 \ \dots \ 0]^T \quad (3.23)$$

where \mathbf{U}' is an $N \times N$ unitary matrix, chosen based on the value of vector \mathbf{h} . By using equations (3.21) and (3.23), we can re-write Eq. (3.20) as in the following [19]

$$y_k = [||\mathbf{h}|| \ 0 \ \dots \ 0] \mathbf{U}'(\mathbf{h}) \mathbf{U}_k [1 \ 0 \ \dots \ 0]^T x_k + w_k \quad (3.24)$$

Considering that \mathbf{U}_k belongs to the circular unitary ensemble, $\mathbf{U}'(\mathbf{h})\mathbf{U}_k = \mathbf{U}_k$ in distribution. As a result, Eq. (3.24) reduces to [19]

$$y_k = \|\mathbf{h}\| \beta_{1,k} x_k + w_k \quad (3.25)$$

Note that in general, $\beta_{1,k}$ can be replaced by any entry of a random unitary matrix drawn from the circular unitary ensemble. For this aim, we only need to change the way of defining β_k and \mathbf{h} in equations (3.21) and (3.23), respectively. Using this scheme, mutual information is given by [19]

$$I = \int_0^1 \log\left(1 + \frac{\|\mathbf{h}\|^2 E_s \eta}{N_0}\right) f_{|\beta_{1,k}|^2}(\eta) d\eta \quad (3.26)$$

where $f_{|\beta_{1,k}|^2}(\eta)$ is the probability density function of the squared magnitude of $\beta_{1,k}$ (or any desired entry of \mathbf{U}_k), and has the following form [19]

$$f_{|\beta_{1,k}|^2}(\eta) = \begin{cases} (N_t - 1)(1 - \eta)^{N_t - 2} & 0 < \eta \leq 1 \\ 0 & \text{otherwise} \end{cases} \quad (3.27)$$

for $N_t \geq 2$, by choosing $\beta_{n,k}$ s according to Eq. (3.22).

The outage probabilities of the above schemes are compared in [19] through simulation. In fact, except for the randomized scheme, the outage probability can be computed analytically for the two transmit antenna case, based on the results in [3]; however, comparison in [19] is only based on simulation results. Simulation results show that none of the schemes outperforms the others in every scenario, and each performs better than the rest only in some cases.

In [20], a random beam-forming method is proposed, for solving a special problem in single frequency networks. Single frequency networks are used in broadcast communication over a wide area. In these networks, several base stations are established in the area, to send data over the same frequency band, thus avoiding hand over from a base station to another when a user is moving from a base station coverage area to another one.

An appropriate option for communication in these networks is OFDM signaling, as the base stations can send the same data over the same sub-carrier, so that users can receive the super-position of the signals, which is usually stronger. However, the channel between each base station and the users generally applies a random phase on the signal, probably resulting in destructive effects. If the channel is frequency selective and data is sent over non-adjacent sub-carriers, only some of the tones may be significantly affected by the destructive super-position. However, if the underlying channel is flat, a destructive effect may influence all the sub-carriers.

To address this issue, a phase randomization technique is proposed in [20]. In every base station, a random phase chosen from a uniform distribution is multiplied to the signal, before the signal is sent over the sub-carriers. The phases are chosen independently for different tones in each base station. By this method, because each tone has a random phase, even in flat fading channels, a destructive super-position will not affect all the tones simultaneously. This method needs no feedback, so it is an appropriate suggestion for the broadcast applications.

In [21], a simple method of random beam-forming is deployed in a MIMO-OFDM system, in order to exploit cyclic delay diversity. Cyclic delay diversity can be exploited in MIMO-OFDM systems, when the underlying OFDM sub-channels experience independent fading. However, if adjacent sub-channels are correlated, diversity gain cannot be achieved totally. In this situation, a random binary phase offset scheme is proposed in [21] to solve the problem. The main idea is to add a pseudo random binary offset (0 or π) to the transmitting symbols of each sub-carrier, before sending them. This idea can be seen as a simple version of random beam-forming, which is applied in a single user scenario to solve the problem caused by the destructive effect of correlation in adjacent sub-channels in an OFDM signal. Moreover, this method is very simple, as it needs no feedback, and uses only binary phase offsets.

3.3.4 Space-time codes

In 1998, Alamouti [11] proposed a very interesting transmit diversity method, using two antennas in the transmitter. The Alamouti scheme needs no CSI in the transmitter side. Moreover, it uses the same time, bandwidth, and power, as the single antenna transmission, but adds more complexity to both transmitter and receiver sides. The method's diversity order is similar to that of MRC method, with two receive antennas [11].

The main idea of the Alamouti scheme is as follows. In symbol period t , two successive symbols x_1 and x_2 are transmitted from the first and the second transmit antenna, respectively. In symbol period $t + 1$, the same symbols are sent with a special coding, i.e., $-x_2^*$ and x_1^* are sent from the first and the second antennas, respectively. In fact, a special code is used in both time (over two successive symbol periods) and space (over two transmit antennas), which justifies the name space-time code. Suppose the receiver has a single antenna, and the channel coefficients between the first transmit antenna and the receive antenna, and the second transmit antenna and the receive antenna are $h_1 = r_1 e^{j\phi_1}$ and $h_2 = r_2 e^{j\phi_2}$, respectively. h_1 and h_2 are assumed to be unchanged during two symbol periods t and $t + 1$. Accordingly, the received signal $y(\cdot)$ will be given as the following in

the two successive symbol periods [11]

$$\begin{aligned} y(t) &= h_1x_1 + h_2x_2 + w(t) \\ y(t+1) &= -h_1x_2^* + h_2x_1^* + w(t+1) \end{aligned} \quad (3.28)$$

where $w(\cdot)$ represents AWGN. In the receiver side, after receiving both $y(t)$ and $y(t+1)$, two combinations of signals are generated as follows [11]

$$\begin{aligned} \tilde{x}_1 &= h_1^*y(t) + h_2y^*(t+1) \\ \tilde{x}_2 &= h_2^*y(t) - h_1y^*(t+1) \end{aligned} \quad (3.29)$$

The two resulting symbols can be simplified by substituting Eq. (3.28) in Eq. (3.29).

$$\begin{aligned} \tilde{x}_1 &= h_1^*(h_1x_1 + h_2x_2 + w(t)) + h_2(-h_1^*x_2 + h_2^*x_1 + w^*(t+1)) \\ &= (r_1^2 + r_2^2)x_1 + h_1^*w(t) + h_2w^*(t+1) \\ \tilde{x}_2 &= h_2^*(h_1x_1 + h_2x_2 + w(t)) - h_1(-h_1^*x_2 + h_2^*x_1 + w^*(t+1)) \\ &= (r_1^2 + r_2^2)x_2 + h_2^*w(t) - h_1w^*(t+1) \end{aligned} \quad (3.30)$$

As can be inferred from Eq. (3.30), the result is almost the same as that of MRC method with two receive antennas (Eq. (3.4)). The method can be generalized to the case of N_r receive antennas, in order to get the diversity order of $2N_r$ [11].

In [7] the idea of the Alamouti scheme is generalized for any number of transmit antennas. Consider the case of a MIMO system with N_t transmit antennas and N_r receive antennas. Suppose that signal $x_i(t)$ is transmitted through the i th transmit antenna in time-slot t , $i = 1, 2, \dots, N_t$ and $t = 1, 2, \dots, T$, where T is the frame length. Moreover, assume that signal $e_i(t)$ is the corresponding signal, recovered in the receiver side. Note that this structure is a space-time code, as it spreads both in space (over transmit antennas) and time (over time-slots of a frame). Then, $N_t \times T$ matrix \mathbf{B} is constructed by computing the differences between the transmitted signals and what is recovered in the receiver side, as follows [7].

$$\mathbf{B} = \begin{pmatrix} e_1(1) - x_1(1) & e_1(2) - x_1(2) & \cdots & e_1(T) - x_1(T) \\ e_2(1) - x_2(1) & e_2(2) - x_2(2) & \cdots & e_2(T) - x_2(T) \\ \vdots & \vdots & \ddots & \vdots \\ e_{N_t}(1) - x_{N_t}(1) & e_{N_t}(2) - x_{N_t}(2) & \cdots & e_{N_t}(T) - x_{N_t}(T) \end{pmatrix} \quad (3.31)$$

Note that matrix \mathbf{B} depends on signals x and e . A main criterion has been given in [7] for choosing space-time codes with a desired diversity order, in Rayleigh fading channels. The

criterion claims that matrix \mathbf{B} has to have a full rank for all of the realizations of signals x and e , in order to achieve the maximum diversity order of the system, which is equal to $N_t N_r$. In fact, the system diversity order depends on the minimum rank of \mathbf{B} over all of its realization. If the minimum rank is equal to r_{min} , then the diversity order is equal to $r_{min} N_t$ [7]. Some special codes are also proposed in [7] for certain specific scenarios.

Chapter 4

Quantized random phase shifting

4.1 Introduction

In Chapter 3, several ideas for exploiting transmit diversity have been introduced in three main categories, based on the assumption about CSIT. The Assumption of full CSIT, although results in optimal schemes, cannot be realized in most scenarios. In particular, it is not a realistic assumption for a communication network, as many users are often involved in the network, and efficient use of spectrum is usually very important. The assumption of providing partial CSI for the transmitter is more realistic, and can be realized in multicast networks. However, for broadcast networks, where one transmitter sends the same data to many receivers, this assumption may not be feasible, because of adding complexity to the network, as well as wasting bandwidth. On the other hand, as opposed to multicast networks, same data is sent to all the receivers, so providing at least partial CSI for the transmitter is not crucial to exploit diversity.

In this chapter, a broadcast network is considered, and a new method of transmit diversity is proposed, assuming no CSIT. This method is categorized in the class of random beam-forming methods. The main idea is similar to the randomized method, proposed in [19] (refer to section 3.3.3), but with two differences. Firstly, only phases of random multipliers are changed randomly, and their amplitudes are constant. Secondly, a quantized version of phases is used. As a result, our proposed scheme benefits the fact that the random multipliers can be multiplied to the transmitted symbols in the RF part of the communication system. This possibility makes the method's implementation simpler, in comparison with the other methods. A similar idea has been proposed in [21] (refer to section 3.3.3), but only the case of two random phases (0 or π) is considered, and the goal

is to de-correlate adjacent OFDM sub-bands.

For modelling the system, a two-antenna transmitter and many single-antenna receivers are considered. As the receivers are receiving same data, only the performance of one receiver is studied from now on. Furthermore, it is assumed that same data is transmitted over the two transmit antennas, but with different phases. To be more precise, one of the antennas simply transmits data symbols, while the other multiplies each of data symbols by a random phase, before transmitting them. Phases are chosen independently and pseudo-randomly from a pre-determined set with the cardinality N_Θ (say $\Theta = \{\theta_1, \theta_2, \dots, \theta_{N_\Theta}\}$) in each time-slot.

The underlying channels are assumed to be slow-faded, so that the channel coefficients remain unchanged for the whole communication interval. Additionally, the channels between the first transmit antenna and the receive antenna, and the second transmit antenna and the receive antenna, with coefficients h_1 and h_2 respectively, are assumed to be under independent identically distributed Rayleigh fading. In fact, the reason of using two antennas along with random phases is forcing the channel to become fast-faded.

Assume that signals $x_1(t) = \frac{x(t)}{\sqrt{2}}$ and $x_2(t) = \frac{x(t)}{\sqrt{2}}e^{j\theta(t)}$ are transmitted from the first and the second antennas respectively, where $x(t)$ is the main transmitting signal. Note that as same data is transmitted over the two antennas, the total power has to be divided among the antennas, i.e., $\frac{x(t)}{\sqrt{2}}$ is sent from each of them. Additionally, $\theta(t)$ represents the phase chosen randomly from the set Θ , and multiplied to the transmitting signal in time slot t , before sending it via the second antenna. Accordingly, the received signal $y(t)$ is given by

$$y(t) = h_1x_1(t) + h_2x_2(t) + w(t) = \frac{1}{\sqrt{2}}(h_1 + h_2e^{j\theta(t)})x(t) + w(t) \quad (4.1)$$

where $w(t)$ is the AWGN. Note that by introducing

$$h(t) = \frac{1}{\sqrt{2}}(h_1 + h_2e^{j\theta(t)}) \quad (4.2)$$

our proposed system model is equivalent to a system with a single-antenna transmitter and a fast-faded channel with the channel coefficient $h(t)$. A schematic figure of our system is depicted in Fig. (4.1).

In order to choose the random phase set Θ , considering that, based on the assumptions the channel coefficients' phases are uniformly distributed over $(0, 2\pi]$, and no direction is preferable than the others, it is reasonable to select random phases from a uniform distribution. Consequently, in order to have a phase set of size N_Θ , the set is determined to be $\Theta = \left\{ \frac{2\pi(i-1)}{N_\Theta} \right\}_{i=1}^{N_\Theta}$.

The rest of this chapter is organized as follows. In section 4.2, the system is studied

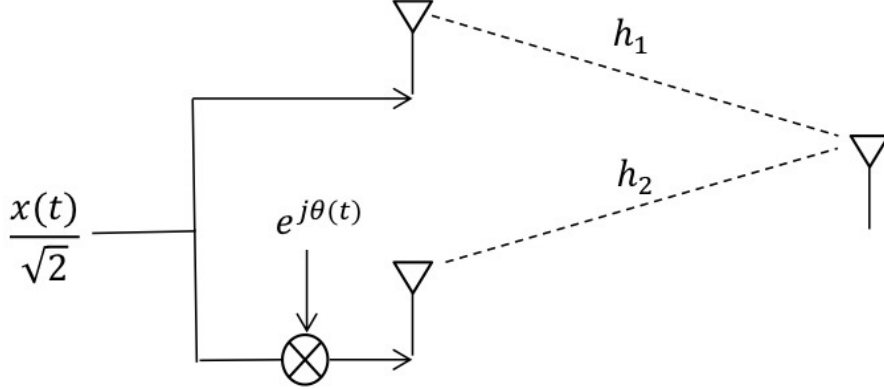

Figure 4.1: A schematic model of the proposed scheme

from an information theoretic view. For this aim, first the corresponding channel capacity is derived. Then, outage probability is analyzed both theoretically and through simulation results. Section 4.3 is dedicated to observe the performance of the proposed scheme in comparison with two other methods. Finally, diversity order of the system is derived, and compared with some other methods in section 4.4.

4.2 Outage probability

In this section, the proposed system is analyzed from an information theoretic view. As mentioned earlier, the underlying channel is assumed to be slow-faded. Thus, the system's outage capacity will be studied. For this aim, first the channel capacity, as a function of channels' coefficients is to be derived. Channel capacity as a function of $h(t)$ (Eq. (4.2)) can be easily derived as

$$C(h(t)) = \log(1 + \rho|h(t)|^2) = \log\left(1 + \frac{\rho}{2} |h_1 + h_2 e^{j\theta(t)}|^2\right) \quad (4.3)$$

where ρ is the system SNR, computed by dividing the total signal power to the AWGN power. Assuming long enough block length, and considering that the random phases are chosen independently in each time-slot, the capacity can be derived as a function of h_1 and h_2 , by averaging over all possible choices of random phases (calculating the expectation over phases). Considering that phases are chosen equally likely in each time slot, the

capacity will be given by

$$C(h_1, h_2) = \frac{1}{N_\Theta} \sum_{i=1}^{N_\Theta} \log \left(1 + \frac{\rho}{2} |h_1 + h_2 e^{j\theta_i}|^2 \right) \quad (4.4)$$

where $\theta_i = \frac{2\pi(i-1)}{N_\Theta}$, for $i = 1, 2, \dots, N_\Theta$. Accordingly, if the phase set cardinality (N_Θ) goes to infinity, i.e. phases are chosen uniformly from the a continuous interval of $[0, 2\pi)$, the asymptotic channel capacity will be as follows.

$$C(h_1, h_2) = \frac{1}{2\pi} \int_{-\pi}^{\pi} \log \left(1 + \frac{\rho}{2} |h_1 + h_2 e^{j\theta}|^2 \right) d\theta \quad (4.5)$$

The capacity derived in Eq. (4.5) is equal to the mutual information of the two-path channel introduced in section 2.2 (Eq. (2.9)), Assuming $W = 1$. Using this equality, the asymptotic outage probability of our proposed method will be as in the following, using Eq. (2.17).

$$\begin{aligned} P_{out} &= \text{Prob} \{C(h_1, h_2) < R\} \\ &= 1 - \left(1 + \frac{2^R - 1}{\rho/2} \right) e^{-\frac{2^R - 1}{\rho/2}} + \frac{1}{(\rho/2)^2} e^{-\frac{2(2^R - 2^{R/2})}{\rho/2}} \int_0^{(2^{R/2} - 1)^2} \sqrt{\gamma(\gamma + 4 \times 2^{R/2})} e^{\frac{\gamma}{\rho/2}} d\gamma \end{aligned} \quad (4.6)$$

In derivation of Eq. (4.6), σ_1^2 is set to be equal to $\frac{1}{2}$, because of the assumption of identically distributed Rayleigh fading channels. In the general case, outage probability is defined as follows.

$$P_{out} = \text{Prob} \{C(h_1, h_2) < R\} = \text{Prob} \left\{ \prod_{i=1}^{N_\Theta} \left(1 + \frac{\rho}{2} |h_1 + h_2 e^{j\theta_i}|^2 \right) < 2^{N_\Theta R} \right\} \quad (4.7)$$

Unfortunately, a closed form could not be derived for the general case, and the analysis is performed based on simulation results. For the case of $N_\Theta = 2$, i.e. $\Theta = \{0, \pi\}$, outage probability is plotted in Fig. 4.2 as a function of transmission rate R , for different amount of SNRs. By setting higher SNRs in the system, outage probability will decrease for a determined rate.

In a general system, considering outage capacity as the measure, the problem can be analyzed from two different viewpoints. The first viewpoint considers a determined transmission rate, and tries to minimize the outage probability. Fig. 4.2 depicts this view, where the outage probability is a function of rate. The second point of view considers

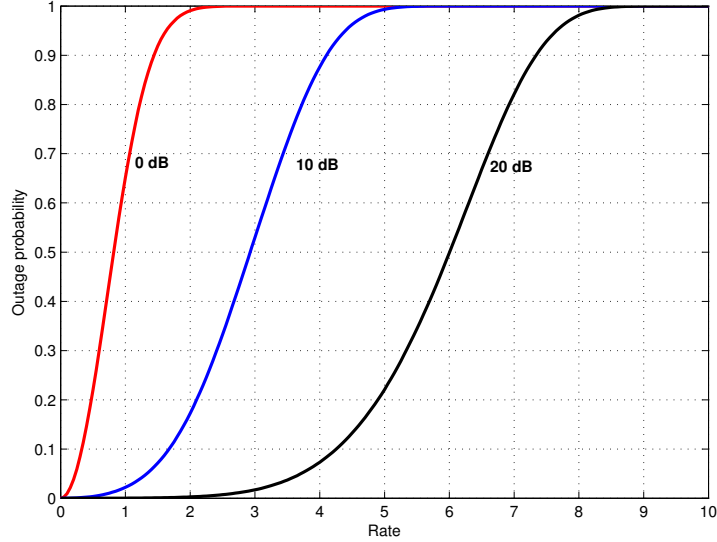

Figure 4.2: Outage probability versus transmission rate, for SNRs 0, 10, and 20 dB, and $N_{\Theta} = 2$

a desired amount of outage probability, and then tries to maximize the transmission rate satisfying that outage probability. In fact, outage capacity is maximized, for a fixed amount of outage probability. In Fig. 4.3, the problem is studied from this point of view, by plotting rate versus SNR for different outage probabilities. It can be inferred that if larger amounts of outage probability are tolerable in the system, higher transmission rates can be achieved. Moreover, for a fixed outage probability, higher SNRs lead to higher rates.

Now, let consider different number of phases in the system, and study the effect of its increase in the outage capacity, given an outage probability. Figures 4.4 and 4.5, depict transmission rate versus SNR using different number of phases, for outage probabilities equal to 0.01 and 0.1, respectively. Figures are plotted for three different number of phases, $N_{\Theta} = 2, 4$ and 64. As can be inferred from the figures, increasing the number of phases results in a bit higher achievable rates, for given outage probabilities. Consequently, although using a phase set with larger cardinality improves the performance, even two phases can be satisfying both in performance and system complexity, instead on the optimal Alamouti scheme.

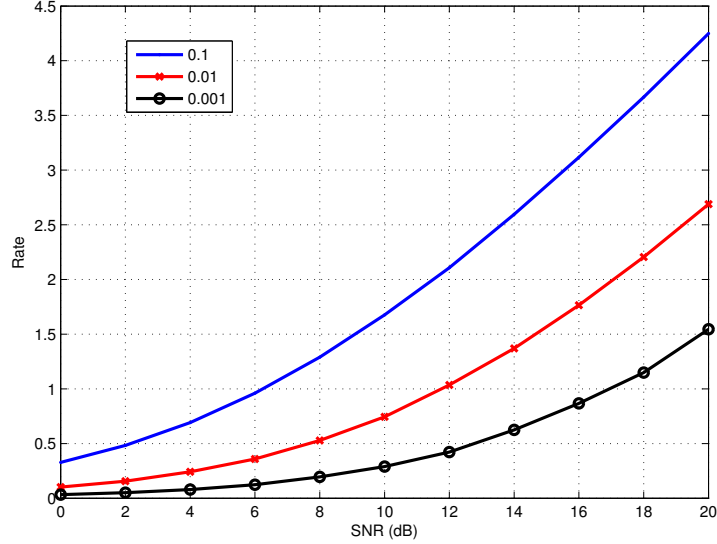

Figure 4.3: Transmission rate versus SNR, for outage probabilities 0.1, 0.01, and 0.001, and $N_{\Theta} = 2$

4.3 Comparison with other methods

In this section, the proposed method's performance is compared with some existent methods. Specially, two methods are chosen for comparison, namely, single-antenna and Alamouti methods. By comparing the proposed scheme with single-antenna method, the performance improvement of adding an extra antenna to the transmitter and using random phases will be observed. Alamouti method, on the other hand, is considered as an optimum scheme to exploit diversity by using two transmit antennas, and assuming no CSIT. In fact, it is important to observe what is lost in term of performance, by applying a sub-optimal method with less complexity.

First, let derive the outage probability formula for single-antenna and Alamouti methods. In single-antenna method, assuming a Rayleigh slow-faded channel, capacity as a function of channel coefficient is derived in Eq. (2.4). As a result, outage probability can be

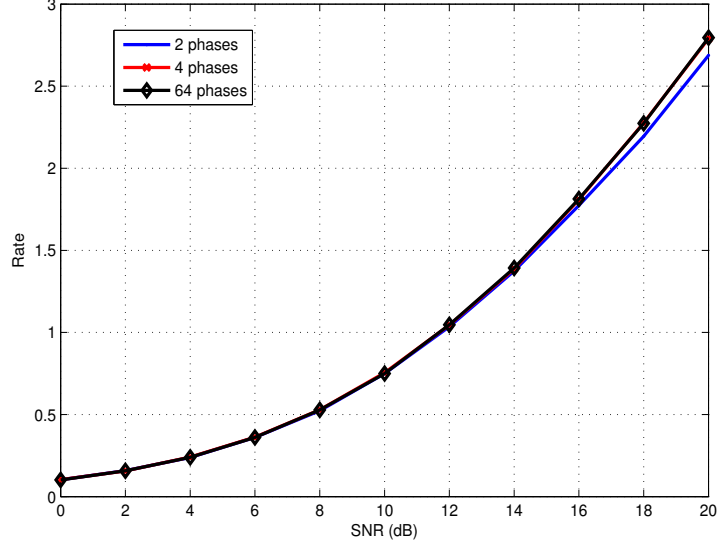

Figure 4.4: Transmission rate versus SNR, for outage probability 0.01, and $N_{\Theta} = 2, 4, 64$

calculated as follows

$$\begin{aligned}
 P_{out,single} &= \text{Prob}\{C(|h|^2) < R\} = \text{Prob}\{1 + |h|^2\rho < 2^R\} = \text{Prob}\left\{|h|^2 < \frac{2^R - 1}{\rho}\right\} \\
 &= 1 - \exp\left(-\frac{2^R - 1}{\rho}\right)
 \end{aligned} \tag{4.8}$$

For Alamouti method, introduced in section 3.3.4, the mutual information between the transmitted signal and the modified version of the received signal (Eq. (3.30)) is considered. Accordingly, assuming two independent Rayleigh channels, the capacity of Alamouti scheme is as follows.

$$C_{Alamouti}(h_1, h_2) = \log\left(1 + \frac{\rho}{2} (|h_1|^2 + |h_2|^2)\right) \tag{4.9}$$

Consequently, outage probability will be given by

$$P_{out,Alamouti} = \text{Prob}\{C_{Alamouti}(h_1, h_2) < R\} = \text{Prob}\left\{|h_1|^2 + |h_2|^2 < \frac{2^R - 1}{\rho/2}\right\} \tag{4.10}$$

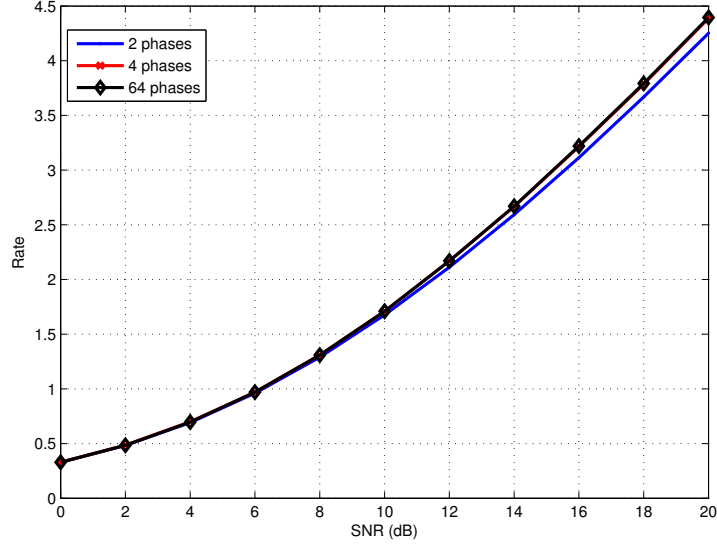

Figure 4.5: Transmission rate versus SNR, for outage probability 0.1, and $N_{\Theta} = 2, 4, 64$

As the channel coefficients h_1 and h_2 are independent, the above probability can be computed, using Gamma distribution.

$$P_{out,Alamouti} = 1 - \left(1 + \frac{2^R - 1}{\rho/2}\right) e^{-\frac{2^R - 1}{\rho/2}} \quad (4.11)$$

It is interesting to note that Eq. (4.11) is equal to the first terms of Eq. (4.6). Considering the fact that the last term in Eq. (4.6) is always positive, i.e.

$$\frac{1}{(\rho/2)^2} e^{-\frac{2(2^R - 2^{R/2})}{\rho/2}} \int_0^{(2^{R/2} - 1)^2} \sqrt{\gamma(\gamma + 4 \times 2^{R/2})} e^{\frac{\gamma}{\rho/2}} d\gamma \geq 0 \quad \text{for all } R, \rho \quad (4.12)$$

the proposed scheme's outage probability for continuous phase set is always greater than that of Alamouti scheme, and the difference is equal to the left-hand side of inequality (4.12).

As the closed form formula for the proposed scheme's outage probability could not be derived, comparison is performed via simulations. First, for two given values of outage probabilities, transmission rate is plotted versus SNR, for the three schemes. In the proposed scheme, N_{Θ} is assumed to be equal to two.

Figures 4.6 and 4.7 depict rate versus SNR for outage probabilities 0.01 and 0.1,

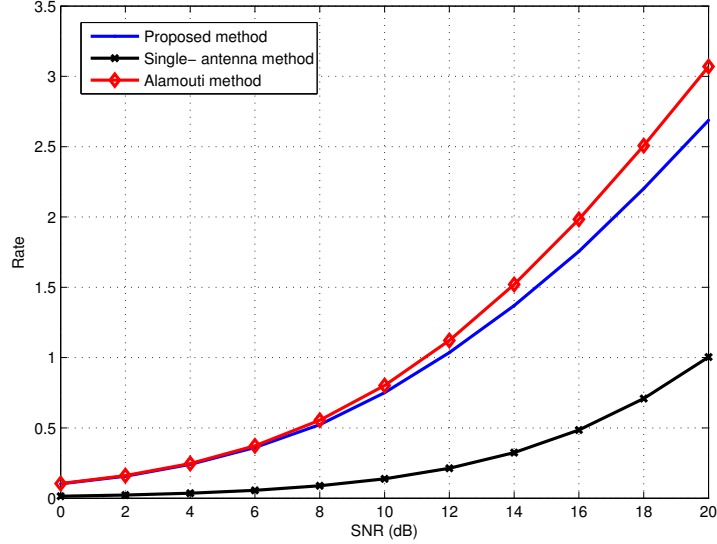

Figure 4.6: Transmission rate versus SNR, for outage probability 0.01, for single-antenna, Alamouti and the proposed methods

respectively. As can be inferred from the figures, the proposed method performs better than single-antenna method, but worse than Alamouti scheme, for the given parameters. In Fig. 4.6, the proposed method’s performance is very close to that of Alamouti scheme, and much better than the single-antenna case. For example, for achieving $R = 1$, SNR has to be about 11 dB in Alamouti scheme. The corresponding amount is about 12 dB for our proposed method, so only one dB gain is lost. On the other hand, SNR is to be almost 20 dB for single-antenna case, i.e. about two times of the proposed method, to get the same rate. However, by releasing outage probability to be limited to 0.1 instead of 0.01, as depicted in Fig. 4.7, the proposed method’s performance gets closer to that of single-antenna case.

The effect of increasing outage probability can be further studied by observing outage probability versus rate plots. Figure 4.8 depicts this plot for $\text{SNR} = 10$ dB, and $N_{\Theta} = 2$ for the proposed scheme. As can be observed, for outage probabilities higher than 0.45, the single-antenna method outperforms the proposed method. It also outperforms Alamouti scheme, when outage probability exceeds 0.7. Although this observation seems to be unexpected, it is in agreement with results in [4] and [5], claiming that for high enough outage probabilities, using one antenna is preferred. To be more accurate, the bound introduced in [5] (Eq. (2.21)) will be used, which is suggested for determining when using all antennas

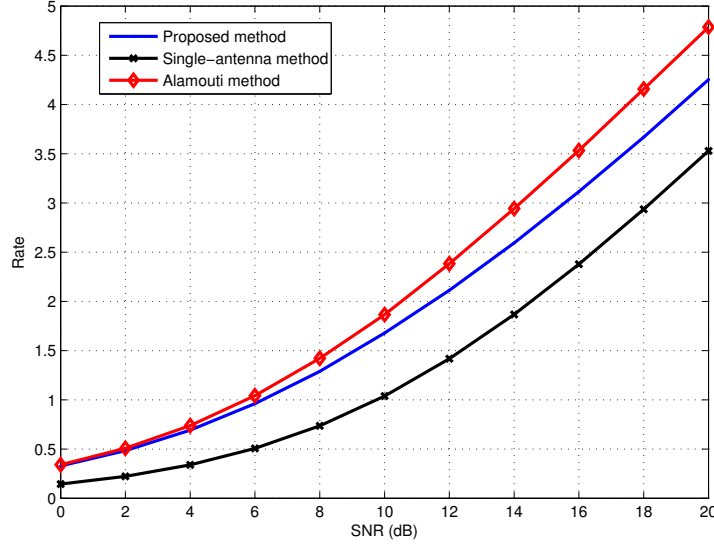

Figure 4.7: Transmission rate versus SNR, for outage probability 0.1, for single-antenna, Alamouti and the proposed methods

(here both antennas) is optimal.

Considering that SNR is set to be 10 dB, this bound reduces to $R < 3.45$, which is included in Fig. 4.8. It can be observed that Alamouti scheme (as a two antenna method) performs better than single-antenna case, for rates below 3.45, while this is not true for the proposed scheme. This observation can be justified by noting that our proposed scheme is sub-optimal. On the other hand, note that for reasonably low outage probabilities, the proposed scheme outperforms single-antenna case, and has a very close performance to the optimal Alamouti scheme.

In order to study the effect of SNR in the results, outage probability versus rate plot is depicted in Fig. 4.9 for SNR = 20 dB. For this case, when outage probability exceeds 0.35, single-antenna method outperforms the proposed scheme, so the proposed scheme is better than single-antenna case for a smaller interval, in comparison with the plot depicted in Fig. 4.8. Considering the fact that when applying more power in the system, generally fewer errors is desired, the proposed method will not perform worse than single-antenna method for desired amounts of outage probability. Additionally, same observations as Fig. 4.8 can be revealed from Fig. 4.9 about the SNR-rate bound. For SNR = 20 dB, when the rate is lower than 6.65, using both of the antennas results in better performance than using just one of the antennas, based on Eq. 2.21. Though this bound holds for Alamouti

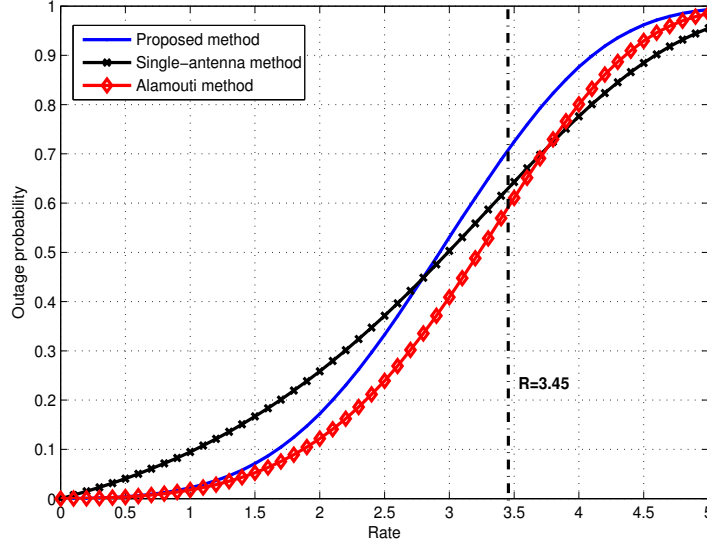

Figure 4.8: Outage probability versus transmission rate in SNR = 10 dB, for single-antenna, Alamouti and the proposed methods

scheme, the sub-optimality of the proposed scheme leads to worse performance compared to single-antenna case, even for rates below the threshold.

Although the complete analytical comparison could not be performed between the proposed scheme and single-antenna method, some analysis has been done to further understand their behaviours. Especially, for different values of channel coefficients' amplitudes, the comparative performances are observed, assuming $N_{\Theta} = 2$ in the proposed scheme. let $h_1 = r_1 e^{j\phi_1}$ and $h_2 = r_2 e^{j\phi_2}$, and $\phi = \phi_2 - \phi_1$. Then, consider the following four regions for r_1 and r_2 .

$$L_1 > 2^{2R} \tag{4.13}$$

$$L_1 < 2^{2R} < L_2 \tag{4.14}$$

$$L_2 < 2^R < L_3 \tag{4.15}$$

$$L_3 < 2^R \tag{4.16}$$

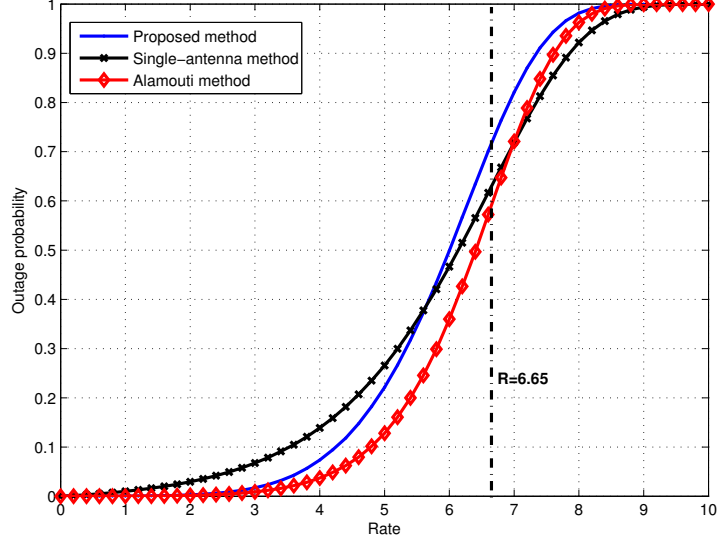

Figure 4.9: Outage probability versus transmission rate in SNR = 20 dB, for single-antenna, Alamouti and the proposed methods

where

$$\begin{aligned}
 L_1 &:= \left[1 + \frac{\rho}{2}(r_1 + r_2)^2\right] \left[1 + \frac{\rho}{2}(r_1 - r_2)^2\right] \\
 L_2 &:= 1 + \frac{\rho}{2}(r_1^2 + r_2^2) \\
 L_3 &:= 1 + \frac{\rho}{2}(r_1 + r_2)^2
 \end{aligned} \tag{4.17}$$

Now, the regions will be observed one-by-one.

1. If r_1 and r_2 satisfy the inequality (4.13), then the proposed scheme's outage probability will be zero. To prove this claim, first we rewrite the outage probability formula of Eq. (4.7) for case of $N_\Theta = 2$, i.e. $\Theta = \{0, \pi\}$.

$$\begin{aligned}
 P_{out} &= \text{Prob} \left\{ \prod_{i=1}^2 \left(1 + \frac{\rho}{2}|h_1 + h_2 e^{j\theta_i}|^2\right) < 2^{2R} \right\} \\
 &= \text{Prob} \left\{ \left(1 + \frac{\rho}{2}|h_1 + h_2 e^{j0}|^2\right) \left(1 + \frac{\rho}{2}|h_1 + h_2 e^{j\pi}|^2\right) < 2^{2R} \right\} \\
 &= \text{Prob} \left\{ \left(1 + \frac{\rho}{2}|h_1 + h_2|^2\right) \left(1 + \frac{\rho}{2}|h_1 - h_2|^2\right) < 2^{2R} \right\}
 \end{aligned} \tag{4.18}$$

Accordingly, we have

$$\begin{aligned}
& \left(1 + \frac{\rho}{2}|h_1 + h_2|^2\right) \left(1 + \frac{\rho}{2}|h_1 - h_2|^2\right) \\
&= \left(1 + \frac{\rho}{2}|r_1 + r_2 e^{j\phi}|^2\right) \left(1 + \frac{\rho}{2}|r_1 - r_2 e^{j\phi}|^2\right) \\
&= \left[1 + \frac{\rho}{2}(r_1^2 + r_2^2 + 2r_1 r_2 \cos \phi)\right] \left[1 + \frac{\rho}{2}(r_1^2 + r_2^2 - 2r_1 r_2 \cos \phi)\right] \\
&= \left[1 + \frac{\rho}{2}(r_1^2 + r_2^2)\right]^2 - \left(2\frac{\rho}{2}r_1 r_2 \cos \phi\right)^2 \\
&\geq \left[1 + \frac{\rho}{2}(r_1^2 + r_2^2)\right]^2 - \left(2\frac{\rho}{2}r_1 r_2\right)^2 \\
&= \left[1 + \frac{\rho}{2}(r_1 + r_2)^2\right] \left[1 + \frac{\rho}{2}(r_1 - r_2)^2\right] = L_1
\end{aligned} \tag{4.19}$$

By substituting inequality (4.19) into Eq. (4.18), and considering that inequality (4.13) holds, P_{out} will be zero. As a result, we have $P_{out} \leq P_{out,single}$ for this case.

2. If r_1 and r_2 satisfy the inequality (4.14), both P_{out} and $P_{out,single}$ can be greater than zero, and we could not derive any general inequality for them in this region.
3. If r_1 and r_2 satisfy the inequality (4.15), $P_{out} = 1$, i.e. the proposed method always results in outage. To justify this claim, an upper-bound is given for the left-hand side of the inequality (4.19), as follows.

$$\begin{aligned}
& \left[1 + \frac{\rho}{2}(r_1^2 + r_2^2)\right]^2 - \left(2\frac{\rho}{2}r_1 r_2 \cos \phi\right)^2 \\
&\leq \left[1 + \frac{\rho}{2}(r_1^2 + r_2^2)\right]^2 = L_2^2
\end{aligned} \tag{4.20}$$

By substituting inequality (4.20) into Eq. (4.18), and considering that inequality (4.15) holds, P_{out} will be one. On the other hand, $P_{out,single} \leq 1$, so $P_{out,single} \leq P_{out}$.

4. Finally, if r_1 and r_2 satisfy the inequality (4.16), it can easily be inferred that outage probability is one for both schemes.

Based on the values of SNR and transmission rate, the probability of the above regions may differ, so that the overall outage probability in the proposed scheme exceeds or falls below that of single-antenna method. In fact the proposed method share the power among two antennas, and because of the way random phases are chosen, the average received power will not meet its lowest bound. Consequently, it is better than single-antenna case for

pretty low rates. On the other hand, the scheme's average power cannot meet its highest bound. Thus, for high rates single-antenna method is stronger.

As the last part of this section, the proposed method's outage probability will be observed as a function of transmission rate, when the phase number N_Θ is changed. The case of $N_\Theta = 1$ is also considered in this part. Note that this case represents single-antenna method, because $\Theta = \{0\}$. Accordingly, equivalent channel gain $h(t)$, introduced in Eq. (4.2), will be reduced to $h(t) = \frac{1}{2}(h_1 + h_2)$, which is equal to a non-varying coefficient h_0 with the same distribution as h_1 and h_2 . As a result, h_0 can be interpreted as a realization of any of the two channels, so this case is equivalent to the single-antenna method.

Fig. 4.10 depicts outage probability versus transmission rate for phase numbers

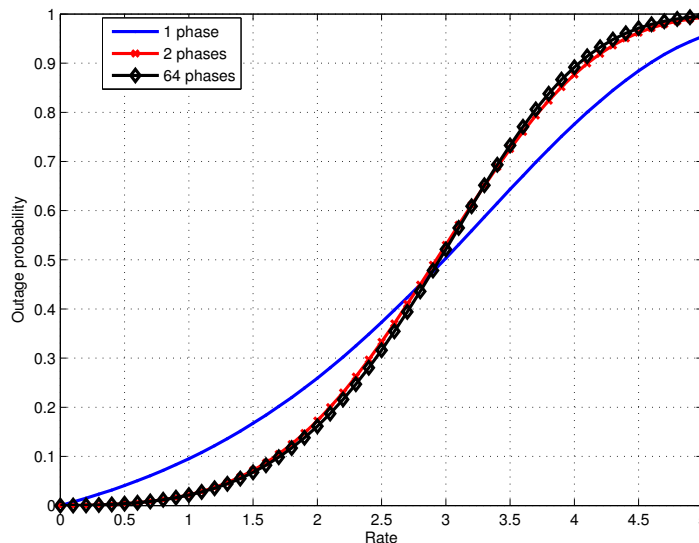

Figure 4.10: Outage probability versus transmission rate in SNR = 10 dB, for $N_\Theta = 1, 2$ and 64

1, 2 and 64, assuming SNR is equal to 10 dB. The case $N_\Theta = 64$ is considered as an approximation of continuous phase set. It is interesting to note that $N_\Theta = 2$ is never optimal. In fact, its performance is always between that of $N_\Theta = 1$ and $N_\Theta = 64$ cases. This result has been confirmed through simulations considering different values of SNR. Consequently, we claim that for different values of outage probability, either one phase (equivalently, single-antenna method), or continuous phase set ($\Theta = [0, 2\pi)$) are optimal. Nevertheless, simulations also show that using small number of phases has a very small effect on the performance, in comparison with $\Theta = [0, 2\pi)$. Thus, considering simpler

system design, they can be used without a significant loss in performance.

4.4 Diversity order

Diversity order, as introduced in section 3.2, originally is defined by Eq. (3.1). However, it can be shown ([9]) that it could also be defined using outage probability, as in the following

$$d = - \lim_{\rho \rightarrow \infty} \frac{\log P_{out}(\rho)}{\log \rho} \quad (4.21)$$

In fact, error probability is approximated by outage probability in the later definition. In this section, using definition in Eq. (4.21), some efforts have been made toward deriving the proposed method's diversity order.

Before focusing on the proposed scheme, diversity order for single-antenna and Alamouti schemes is derived. For single-antenna method, by substituting Eq. (4.8) in Eq. (4.21), diversity order can be derived as

$$\begin{aligned} d &= - \lim_{\rho \rightarrow \infty} \frac{\log \left(1 - \exp\left(-\frac{2^R-1}{\rho}\right) \right)}{\log \rho} \approx - \lim_{\rho \rightarrow \infty} \frac{\log \left(1 - \left(1 - \frac{2^R-1}{\rho}\right) \right)}{\log \rho} \\ &= \lim_{\rho \rightarrow \infty} \left(1 - \frac{\log(2^R - 1)}{\log \rho} \right) = 1 \end{aligned} \quad (4.22)$$

where the approximation comes from the fact that $e^x \approx 1 + x$ for very small x . The result is expected, as single-antenna method offers no diversity gain. For Alamouti scheme, an equivalent method of deriving diversity order will be applied, where an approximation of outage probability for very large SNR region is derived, in the form of $\alpha\rho^{-d} + o(\rho^{-d})$, where α is a coefficient independent of ρ , and $o(\rho^{-d})$ contains terms with higher degree of ρ . Accordingly, from Eq. (4.11), Alamouti scheme's diversity order will be given by

$$\begin{aligned} P_{out,Alamouti} &= 1 - \left(1 + \frac{2^R - 1}{\rho/2} \right) e^{-\frac{2^R-1}{\rho/2}} \approx 1 - \left(1 + \frac{2^R - 1}{\rho/2} \right) \left(1 - \frac{2^R - 1}{\rho/2} \right) \\ &= 1 - \left[1 - \left(\frac{2^R - 1}{\rho/2} \right)^2 \right] = 4(2^R - 1)^2 \rho^{-2} \end{aligned} \quad (4.23)$$

As a result, $d_{Alamouti} = 2$, which is expected, as Alamouti scheme achieves full diversity gain of using two antennas. For the proposed scheme, outage probability has only been

derived for the case of continuous phase set, given in Eq. (4.6). Using the result of Eq. (4.23), the proposed system's diversity order for this case will be derived as follows.

$$\begin{aligned}
P_{out} &= P_{out, Alamouti} + \frac{1}{(\rho/2)^2} e^{-\frac{2(2^R - 2^{R/2})}{\rho/2}} \int_0^{(2^{R/2}-1)^2} \sqrt{\gamma(\gamma + 4 \times 2^{R/2})} e^{\frac{\gamma}{\rho/2}} d\gamma \\
&\approx 4(2^R - 1)^2 \rho^{-2} + \frac{4}{\rho^2} \left(1 - \frac{2(2^R - 2^{R/2})}{\rho/2}\right) \int_0^{(2^{R/2}-1)^2} \sqrt{\gamma(\gamma + 4 \times 2^{R/2})} \left(1 + \frac{\gamma}{\rho/2}\right) d\gamma \\
&= 4 \left[(2^R - 1)^2 + \int_0^{(2^{R/2}-1)^2} \sqrt{\gamma(\gamma + 4 \times 2^{R/2})} d\gamma \right] \rho^{-2} \\
&\quad + 8 \left[\int_0^{(2^{R/2}-1)^2} (\gamma - 2(2^R - 2^{R/2})) \sqrt{\gamma(\gamma + 4 \times 2^{R/2})} d\gamma \right] \rho^{-3} \\
&\quad - 16 \left[2(2^R - 2^{R/2}) \int_0^{(2^{R/2}-1)^2} \gamma \sqrt{\gamma(\gamma + 4 \times 2^{R/2})} d\gamma \right] \rho^{-4} \\
&= \alpha \rho^{-2} + o(\rho^{-2})
\end{aligned} \tag{4.24}$$

As a result, the proposed diversity order for the case of $\Theta = [0, 2\pi)$ is equal to two, similar to Alamouti scheme. For other cases, the results are based on simulations. For deriving diversity order, outage probability versus SNR has to be plotted for a given transmission rate. Fig. 4.11 depicts this plot for the proposed method when $N_\Theta = 2$, assuming that transmission rate is equal to one. Corresponding plots for Alamouti and single-antenna schemes are depicted for comparison. SNR is varied from 10 dB to 30 dB, as the behaviour in high SNRs is to be observed. As can be inferred from the figure, The behaviour of the proposed method is similar to that of Alamouti scheme in high SNR regions. Specifically, by observing the curves in the 20 – 30 dB region of SNR, it can be seen that the curve slope of the proposed and Alamouti schemes is obviously equal to two, while it is one for single-antenna method. This result justifies that the proposed scheme has diversity order of two.

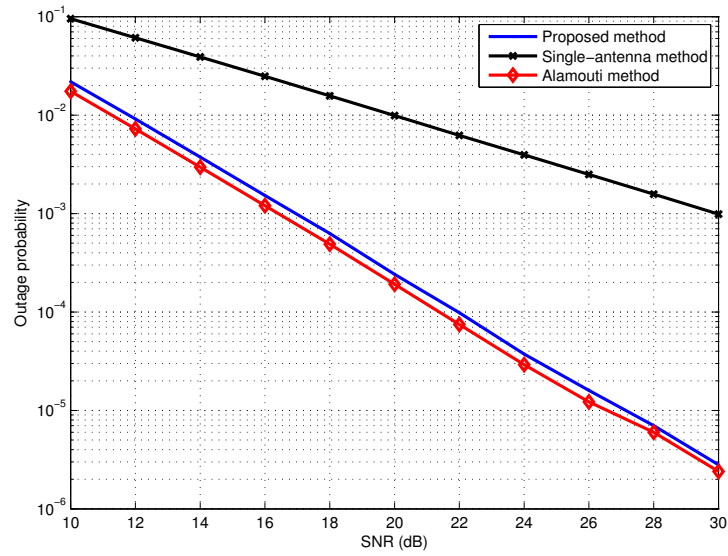

Figure 4.11: Outage probability versus SNR, in $R = 1$, for single-antenna, Alamouti and the proposed methods

Chapter 5

Conclusions and future works

5.1 Conclusions

Diversity exploitation can be regarded as the most powerful way to solve the problem of multi-path fading in wireless communication systems. Among all methods for exploiting diversity, spatial diversity techniques are appropriate methods in slow and flat-faded channels. In the downlink of communication networks, spatial diversity may not be provided by settling the antennas in the receivers, as mobile receivers have to be small and cheap. As a result, transmit diversity techniques are used for these scenarios, to provide diversity by using several antennas in the transmitter. The amount of channel state information provided for the transmitter is one of the important differences among various transmit diversity methods.

In this thesis, a new transmit diversity technique is proposed for a broadcast network with an underlying slow-faded channel. It is assumed that no channel state information is provided for the transmitter, so that our scheme can be easily deployed in broadcast networks. The main idea of our proposed scheme is to multiply random phases to data symbols, before transmission. The performance of this scheme is studied by analyzing the outage probability.

The system is analyzed both theoretically and through simulations. Theoretical derivation of outage probability could only be performed for the case of continuous phase set. It is illustrated through simulations that even a selection of two random phases (0 or π) may provide a satisfying performance. Comparing the performance of our proposed method with that of single-antenna (no diversity exploitation) scheme illustrates great improvements in reasonably low outage probability regions. Moreover, the proposed method's

performance is slightly worse than that of the optimal Alamouti scheme. Thus, considering complexity issues, our proposed scheme may be preferred in certain scenarios.

Diversity order of the proposed scheme is also derived. For the case of continuous phase set, theoretical analysis has been performed, revealing a diversity order of two for the scheme. As a result, this scheme exploits full diversity order. Simulation results have shown that the same diversity order can be exploited even for the case of two random phases.

5.2 Future works

In this section, some suggestions are provided to further improve the works of this thesis.

- Unfortunately, except for the case of continuous phase set, the theoretical analysis of outage probability and diversity order could not be provided. Some efforts have been made in this regard, but could not be completed. Derivation of outage probability for the general case can be considered as a following work.
- The proposed scheme is only analyzed for the case of two transmit antennas, which can be generalized to the case of N_t transmit antennas. Moreover, general MIMO case (assuming N_r antennas in the receiver) can also be considered.
- The proposed scheme can be adapted to exploit receive diversity, by establishing the antennas on the receiver side. A comparison can be also performed with EGC method.
- The proposed method is only studied assuming Rayleigh fading channels. A generalization to interference channels can be considered.

References

- [1] T. Cover, and J. Thomas, *Elements of Information Theory*, Wiley-interscience, 2006.
- [2] E. Biglieri, J. Proakis, S. Shamai, “Fading Channels: Information-Theoretic and Communications Aspects,” *IEEE Transactions on Information Theory*, Vol. 44, Issue 6, 1998.
- [3] L. Ozarow, S. Shamai, A. Wyner, “Information Theoretic Considerations for Cellular Mobile Radio,” *IEEE Transactions on Vehicular Technology*, Vol. 43, Issue 2, 1994.
- [4] E. Telatar, “Capacity of Multi-Antenna Gaussian Channels,” *European Transactions on Telecommunications*, Vol. 10, Issue 6, 1999.
- [5] E. Jorswieck, H. Boche, “Outage probability in multiple antenna systems,” *European Transactions on Telecommunications*, Vol. 18, Issue 3, 2007.
- [6] E. Abbe, S. Huang, E. Telatar, “Proof of the outage probability conjecture for MISO channels,” available at <http://arxiv.org/abs/1103.5478>.
- [7] V. Tarokh, N. Seshadri, A. Calderbank, “Space-Time Codes for High Data Rate Wireless Communication: Performance Criterion and Code Construction,” *IEEE Transactions on Information Theory*, Vol. 44, Issue 2, 1998.
- [8] P. Viswanath, D. Tse, R. Laroia, “Opportunistic beamforming using dumb antennas,” *IEEE Transactions on Information Theory*, Vol. 48, Issue 6, 2002.
- [9] D. Tse, “Diversity and multiplexing: a fundamental tradeoff in multiple-antenna channels,” *IEEE Transactions on Information Theory*, Vol. 49, Issue 5, 2003.
- [10] M. Simon, and M. Alouini, *Digital Communication over Fading Channels*, Vol. 86. Wiley-IEEE Press, 2004.

- [11] S.M. Alamouti, "A Simple Transmit Diversity Technique for Wireless Communications," *IEEE Journal on Selected Areas in Communications*, Vol. 16, Issue 8, 1998.
- [12] J. Chung, C. Hwang, K. Kim, Y. Kim, "A Random Beamforming Technique in MIMO Systems Exploiting Multiuser Diversity," *IEEE Journal on Selected Areas in Communications*, Vol. 21, Issue 5, 2003.
- [13] A. Hiroike, F. Adachi, N. Nakajima, "Combined Effects of Phase Sweeping Transmitter Diversity and Channel Coding," *IEEE Transactions on Vehicular Technology*, Vol. 41, Issue 2, 1992.
- [14] M. Sharif, B. Hassibi, "On the Capacity of MIMO Broadcast Channels With Partial Side Information," *IEEE Transactions on Information Theory*, Vol. 51, Issue 2, 2005.
- [15] J. Vicario, R. Bosisio, C. Anton-haro, U. Spagnolini, "Beam Selection Strategies for Orthogonal Random Beamforming in Sparse Networks," *IEEE Transactions on Wireless Communications*, Vol. 7, Issue 9, 2008.
- [16] M. Kountouris, D. Gesbert, T. Sizer, "Enhanced Multiuser Random Beamforming: Dealing With the Not So Large Number of Users Case," *IEEE Journal on Selected Areas in Communications*, Vol. 26, Issue 8, 2008.
- [17] P. Svedman, S. Wilson, L. Cimini, B. Ottersten, "Opportunistic Beamforming and Scheduling for OFDMA Systems," *IEEE Transactions on Communications*, Vol. 55, Issue 5, 2007.
- [18] N. Sharma, L. Ozarow, "A Study of Opportunism for Multiple-Antenna Systems," *IEEE Transactions on Information Theory*, Vol. 51, Issue 5, 2005.
- [19] A. Narula, M.D. Trott, G.W. Wornell, "Performance Limits of Coded Diversity Methods for Transmitter Antenna Arrays," *IEEE Transactions on Information Theory*, Vol. 45, Issue 7, 1999.
- [20] K. Rege, K. Balachandran, J. Kang, K. Karakayali, "Performance Enhancement of Single Frequency Networks Using Randomized Transmit Phases," *IEEE Globecom 2010 proceedings*, 2010.
- [21] A. Sadeque, M. Saquib, "Pseudo Random Binary Phase Offset Scheme for Multi-Carrier Delay Diversity Modulation," *IEEE Transactions on Wireless Communications*, Vol. 10, Issue 5, 2011.