

Robust Feedback Linearization Control for Reference Tracking and Disturbance Rejection in Nonlinear Systems

Cristina Ioana Pop and Eva Henrietta Dulf

*Technical University of Cluj, Department of Automation, Cluj-Napoca
Romania*

1. Introduction

Most industrial processes are nonlinear systems, the control method applied consisting of a linear controller designed for the linear approximation of the nonlinear system around an operating point. However, even though the design of a linear controller is rather straightforward, the result may prove to be unsatisfactorily when applied to the nonlinear system. The natural consequence is to use a nonlinear controller.

Several authors proposed the method of feedback linearization (Chou & Wu, 1995), to design a nonlinear controller. The main idea with feedback linearization is based on the fact that the system is not entirely nonlinear, which allows to transform a nonlinear system into an equivalent linear system by effectively canceling out the nonlinear terms in the closed-loop (Seo *et al.*, 2007). It provides a way of addressing the nonlinearities in the system while allowing one to use the power of linear control design techniques to address nonlinear closed loop performance specifications.

Nevertheless, the classical feedback linearization technique has certain disadvantages regarding robustness. A robust linear controller designed for the linearized system may not guarantee robustness when applied to the initial nonlinear system, mainly because the linearized system obtained by feedback linearization is in the Brunovsky form, a non robust form whose dynamics is completely different from that of the original system and which is highly vulnerable to uncertainties (Franco, *et al.*, 2006). To eliminate the drawbacks of classical feedback linearization, a robust feedback linearization method has been developed for uncertain nonlinear systems (Franco, *et al.*, 2006; Guillard & Bourles, 2000; Franco *et al.*, 2005) and its efficiency proved theoretically by W-stability (Guillard & Bourles, 2000). The method proposed ensures that a robust linear controller, designed for the linearized system obtained using robust feedback linearization, will maintain the robustness properties when applied to the initial nonlinear system.

In this paper, a comparison between the classical approach and the robust feedback linearization method is addressed. The mathematical steps required to feedback linearize a nonlinear system are given in both approaches. It is shown how the classical approach can be altered in order to obtain a linearized system that coincides with the tangent linearized system around the chosen operating point, rather than the classical chain of integrators. Further, a robust linear controller is designed for the feedback linearized system using loop-

shaping techniques and then applied to the original nonlinear system. To test the robustness of the method, a chemical plant example is given, concerning the control of a continuous stirred tank reactor.

The paper is organized as follows. In Section 2, the mathematical concepts of feedback linearization are presented – both in the classical and robust approach. The authors propose a technique for disturbance rejection in the case of robust feedback linearization, based on a feed-forward controller. Section 3 presents the H_∞ robust stabilization problem. To exemplify the robustness of the method described, the nonlinear robust control of a continuous stirred tank reactor (CSTR) is given in Section 4. Simulations results for reference tracking, as well as disturbance rejection are given, considering uncertainties in the process parameters. Some concluding remarks are formulated in the final section of the paper.

2. Feedback linearization: Classical versus robust approach

Feedback linearization implies the exact cancelling of nonlinearities in a nonlinear system, being a widely used technique in various domains such as robot control (Robenack, 2005), power system control (Dabo et al., 2009), and also in chemical process control (Barkhordari Yazdi & Jahed-Motlagh, 2009; Pop & Dulf, 2010; Pop et al, 2010), etc. The majority of nonlinear control techniques using feedback linearization also use a strategy to enhance robustness. This section describes the mathematical steps required to obtain the final closed loop control structure, to be later used with robust linear control.

2.1 Classical feedback linearization

2.1.1 Feedback linearization for SISO systems

In the classical approach of feedback linearization as introduced by Isidori (Isidori, 1995), the Lie derivative and relative degree of the nonlinear system plays an important role. For a single input single output system, given by:

$$\begin{aligned}\dot{x} &= f(x) + g(x)u \\ y &= h(x)\end{aligned}\quad (1)$$

with $x \in \mathfrak{R}^n$ is the state, u is the control input, y is the output, f and g are smooth vector fields on \mathfrak{R}^n and h is a smooth nonlinear function. Differentiating y with respect to time, we obtain:

$$\begin{aligned}\dot{y} &= \frac{\partial h}{\partial x} f(x) + \frac{\partial h}{\partial x} g(x)u \\ \dot{y} &= L_f h(x) + L_g h(x)u\end{aligned}\quad (2)$$

with $L_f h(x): \mathfrak{R}^n \rightarrow \mathfrak{R}$ and $L_g h(x): \mathfrak{R}^n \rightarrow \mathfrak{R}$, defined as the Lie derivatives of h with respect to f and g , respectively. Let U be an open set containing the equilibrium point x_0 , that is a point where $f(x)$ becomes null – $f(x_0) = 0$. Thus, if in equation (2), the Lie derivative of h with respect to g – $L_g h(x)$ – is bounded away from zero for all $x \in U$ (Sastry, 1999), then the state feedback law:

$$u = \frac{1}{L_g h(x)} (-L_f h(x) + v) \quad (3)$$

yields a linear first order system from the supplementary input v to the initial output of the system, y . Thus, there exists a state feedback law, similar to (3), that makes the nonlinear system in (2) linear. The relative degree of system (2) is defined as the number of times the output has to be differentiated before the input appears in its expression. This is equivalent to the denominator in (3) being bounded away from zero, for all $x \in U$. In general, the relative degree of a nonlinear system at $x_0 \in U$ is defined as an integer γ satisfying:

$$\begin{aligned} L_g L_f^i h(x) &\equiv 0, \forall x \in U, i = 0, \dots, \gamma - 2 \\ L_g L_f^{\gamma-1} h(x_0) &\neq 0 \end{aligned} \tag{4}$$

Thus, if the nonlinear system in (1) has relative degree equal to γ , then the differentiation of y in (2) is continued until:

$$y^{(\gamma)} = L_f^\gamma h(x) + L_g L_f^{\gamma-1} h(x) u \tag{5}$$

with the control input equal to:

$$u = \frac{1}{L_g L_f^{\gamma-1} h(x)} \left(-L_f^\gamma h(x) + v \right) \tag{6}$$

The final (new) input - output relation becomes:

$$y^{(\gamma)} = v \tag{7}$$

which is linear and can be written as a chain of integrators (Brunovsky form). The control law in (6) yields $(n-\gamma)$ states of the nonlinear system in (1) unobservable through state feedback.

The problem of measurable disturbances has been tackled also in the framework of feedback linearization. In general, for a nonlinear system affected by a measurable disturbance d :

$$\begin{aligned} \dot{x} &= f(x) + g(x)u + p(x)d \\ y &= h(x) \end{aligned} \tag{8}$$

with $p(x)$ a smooth vector field.

Similar to the relative degree of the nonlinear system, a disturbance relative degree is defined as a value k for which the following relation holds:

$$\begin{aligned} L_p L_f^i h(x) &= 0, i < k - 1 \\ L_p L_f^{k-1} h(x) &\neq 0 \end{aligned} \tag{9}$$

Thus, a comparison between the input relative degree and the disturbance relative degree gives a measure of the effect that each external signal has on the output (Daoutidis and Kravaris, 1989). If $k < \gamma$, the disturbance will have a more direct effect upon the output, as compared to the input signal, and therefore a simple control law as given in (6) cannot ensure the disturbance rejection (Henson and Seborg, 1997). In this case complex feedforward structures are required and effective control must involve anticipatory action

for the disturbance. The control law in (6) is modified to include a dynamic feed-forward/state feedback component which differentiates a state- and disturbance-dependent signal up to $\gamma-k$ times, in addition to the pure static state feedback component. In the particular case that $k=\gamma$, both the disturbance and the manipulated input affect the output in the same way. Therefore, a feed-forward/state feedback element which is static in the disturbance is necessary in the control law in addition to the pure state feedback element (Daoutidis and Kravaris, 1989):

$$u = \frac{1}{L_g L_f^{\gamma-1} h(x)} \left(-L_f^{\gamma} h(x) + v - L_p L_f^{\gamma-1} p(x) d \right) \quad (10)$$

2.1.1 Feedback linearization for MIMO systems

The feedback linearization method can be extended to multiple input multiple output nonlinear square systems (Sastry, 1999). For a MIMO nonlinear system having n states and m inputs/outputs the following representation is used:

$$\begin{aligned} \dot{x} &= f(x) + g(x)u \\ y &= h(x) \end{aligned} \quad (11)$$

where $x \in \mathfrak{R}^n$ is the state, $u \in \mathfrak{R}^m$ is the control input vector and $y \in \mathfrak{R}^m$ is the output vector. Similar to the SISO case, a vector relative degree is defined for the MIMO system in (11). The problem of finding the vector relative degree implies differentiation of each output signal until one of the input signals appear explicitly in the differentiation. For each output signal, we define γ_j as the smallest integer such that at least one of the inputs appears in $y_j^{\gamma_j}$:

$$y_j^{\gamma_j} = L_f^{\gamma_j} h_j + \sum_{i=1}^m L_{g_i} \left(L_f^{\gamma_j-1} h_j \right) u_i \quad (12)$$

and at least one term $L_{g_i} \left(L_f^{\gamma_j-1} h_j \right) u_i \neq 0$ for some x (Sastry, 1999). In what follows we assume that the sum of the relative degrees of each output is equal to the number of states of the nonlinear system. Such an assumption implies that the feedback linearization method is exact. Thus, neither of the state variables of the original nonlinear system is rendered unobservable through feedback linearization.

The matrix $M(x)$, defined as the decoupling matrix of the system, is given as:

$$M = \begin{bmatrix} L_{g_1} \left(L_f^{\gamma_1-1} h_1 \right) & \dots & L_{g_m} \left(L_f^{\gamma_m-1} h_m \right) \\ \dots & \dots & \dots \\ L_{g_1} \left(L_f^{\gamma_1-1} h_m \right) & \dots & L_{g_m} \left(L_f^{\gamma_m-1} h_m \right) \end{bmatrix} \quad (13)$$

The nonlinear system in (11) has a defined vector relative degree r_1, r_2, \dots, r_m at the point x_0 if $L_{g_i} L_f^k h_i(x) \equiv 0$, $0 \leq k \leq r_i - 2$ for $i=1, \dots, m$ and the matrix $M(x_0)$ is nonsingular. If the vector relative degree r_1, r_2, \dots, r_m is well defined, then (12) can be written as:

$$\begin{bmatrix} y_1^r \\ y_2^r \\ \vdots \\ y_m^r \end{bmatrix} = \begin{bmatrix} L_f^r h_1 \\ L_f^r h_2 \\ \vdots \\ L_f^r h_m \end{bmatrix} + M(x) \begin{bmatrix} u_1 \\ u_2 \\ \vdots \\ u_m \end{bmatrix} \tag{14}$$

Since $M(x_0)$ is nonsingular, then $M(x) \in \mathbb{R}^{m \times m}$ is nonsingular for each $x \in U$. As a consequence, the control signal vector can be written as:

$$u = -M^{-1}(x) \begin{bmatrix} L_f^r h_1 \\ L_f^r h_2 \\ \vdots \\ L_f^r h_m \end{bmatrix} + M^{-1}(x)v = \alpha_c(x) + \beta_c(x)v \tag{15}$$

yielding the linearized system as:

$$\begin{bmatrix} y_1^r \\ y_2^r \\ \vdots \\ y_m^r \end{bmatrix} = \begin{bmatrix} v_1 \\ v_2 \\ \vdots \\ v_m \end{bmatrix} \tag{16}$$

The states x undergo a change of coordinates given by:

$$x_c = [y_1 \ \dots \ L_f^{r_1-1} y_1 \ y_2 \ \dots \ L_f^{r_2-1} y_2 \ \dots \ y_m \ \dots \ L_f^{r_m-1} y_m]^T \tag{17}$$

The nonlinear MIMO system in (11) is linearized to give:

$$\dot{x}_c = A_c x_c + B_c v \tag{18}$$

with $A_c = \begin{bmatrix} A_{c_1} & 0_{r_1 \times r_2} & \dots & 0_{r_1 \times r_m} \\ 0_{r_2 \times r_1} & A_{c_2} & \dots & 0_{r_2 \times r_m} \\ \vdots & \vdots & \ddots & \vdots \\ 0_{r_m \times r_1} & 0_{r_m \times r_2} & 0_{r_m \times r_3} & A_{c_m} \end{bmatrix}$ and $B_c = \begin{bmatrix} B_{c_1} & 0_{r_1 \times r_2} & \dots & 0_{r_1 \times r_m} \\ 0_{r_2 \times r_1} & B_{c_2} & \dots & 0_{r_2 \times r_m} \\ \vdots & \vdots & \ddots & \vdots \\ 0_{r_m \times r_1} & 0_{r_m \times r_2} & 0_{r_m \times r_3} & B_{c_m} \end{bmatrix}$, where each

term individually is given by: $A_{c_i} = \begin{bmatrix} 1 & 0 & \dots & 0 \\ 0 & 1 & \dots & 0 \\ \vdots & \vdots & \ddots & \vdots \\ 0 & 0 & 0 & 1 \end{bmatrix}$ and $B_{c_i} = [0 \ 0 \ \dots \ 0 \ 1]^T$.

In a classical approach, the feedback linearization is achieved through a feedback control law and a state transformation, leading to a linearized system in the form of a chain of integrators (Isidori, 1995). Thus the design of the linear controller is difficult, since the linearized system obtained bears no physical meaning similar to the initial nonlinear system

(Pop *et al.*, 2009). In fact, two nonlinear systems having the same degree will lead to the same feedback linearized system.

2.2 Robust feedback linearization

To overcome the disadvantages of classical feedback linearization, the robust feedback linearization is performed in a neighborhood of an operating point, x_0 . The linearized system would be equal to the tangent linearized system around the chosen operating point. Such system would bear similar physical interpretation as compared to the initial nonlinear system, thus making it more efficient and simple to design a controller (Pop *et al.*, 2009; Pop *et al.*, 2010; Franco, *et al.*, 2006).

The multivariable nonlinear system with disturbance vector d , is given in the following equation:

$$\begin{aligned}\dot{x} &= f(x) + g(x)u + p(x)d \\ y &= h(x)\end{aligned}\tag{19}$$

where $x \in \mathfrak{R}^n$ is the state, $u \in \mathfrak{R}^m$ is the control input vector and $y \in \mathfrak{R}^m$ is the output vector. In robust feedback linearization, the purpose is to find a state feedback control law that transforms the nonlinear system (19) in a tangent linearized one around an equilibrium point, x_0 :

$$\dot{z} = Az + Bw\tag{20}$$

In what follows, we assume the feedback linearization conditions (Isidori, 1995) are satisfied and that the output of the nonlinear system given in (19) can be chosen as: $y(x) = \lambda(x)$, where $\lambda(x) = [\lambda_1(x) \dots \lambda_m(x)]$ is a vector formed by functions $\lambda_i(x)$, such that the sum of the relative degrees of each function $\lambda_i(x)$ to the input vector is equal to the number of states of (19).

With the (A, B) pair in (20) controllable, we define the matrices $L(m \times n)$, $T(n \times n)$ and $R(m \times m)$ such that (Levine, 1996):

$$\begin{aligned}T(A - BRL)T^{-1} &= A_c \\ TBR &= B_c\end{aligned}\tag{21}$$

with T and R nonsingular.

By taking:

$$v = LT^{-1}x_c + R^{-1}w\tag{22}$$

And using the state transformation:

$$z = T^{-1}x_c\tag{23}$$

the system in (18) is rewritten as:

$$\dot{x}_c = A_c x_c + B_c LT^{-1} x_c + B_c R^{-1} w = (A_c + B_c LT^{-1}) x_c + B_c R^{-1} w\tag{24}$$

Equation (23) yields:

$$z = T^{-1}x_c \Rightarrow x_c = Tz \tag{25}$$

Replacing (25) into (24) and using (21), gives:

$$\begin{aligned} T\dot{z} &= (A_c + B_cLT^{-1})Tz + B_cR^{-1}v \Rightarrow \dot{z} = T^{-1}(A_c + B_cLT^{-1})Tz + T^{-1}B_cR^{-1}v = \\ &= T^{-1}A_cTz + T^{-1}B_cLT^{-1}Tz + T^{-1}B_cR^{-1}v \\ \dot{z} &= T^{-1}T(A - BRL)T^{-1}Tz + T^{-1}TBRLT^{-1}Tz + T^{-1}TBRR^{-1}v = \\ &= (A - BRL)z + BRLz + Bv = Az + Bv \end{aligned} \tag{26}$$

resulting the linearized system in (20), with $A = \partial_x f(x_0)$ and $B = g(x_0)$. The control signal vector is given by:

$$u = a_c(x) + \beta_c(x)v = a_c(x) + \beta_c(x)LT^{-1}x_c + \beta_c(x)R^{-1}v = a(x) + \beta(x)v \tag{27}$$

The L , T and R matrices are taken as: $L = -M(x_0)\partial_x \alpha_c(x_0)$, $T = \partial_x x_c(x_0)$, $R = M^{-1}(x_0)$ (Franco *et al.*, 2006; Guillard și Bourles, 2000).

Disturbance rejection in nonlinear systems, based on classical feedback linearization theory, has been tackled firstly by (Daoutidis and Kravaris, 1989). Disturbance rejection in the framework of robust feedback linearization has not been discussed so far.

In what follows, we assume that the relative degrees of the disturbances to the outputs are equal to those of the inputs. Thus, for measurable disturbances, a simple static feedforward structure can be used (Daoutidis and Kravaris, 1989; Daoutidis *et al.*, 1990). The final closed loop control scheme used in robust feedback linearization and feed-forward compensation is given in Figure 1, (Pop *et al.*, 2010).

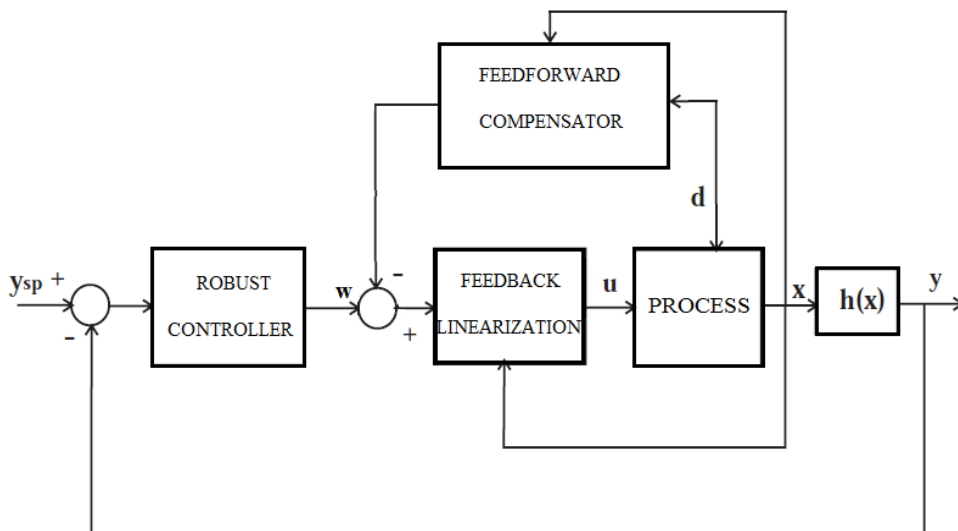

Fig. 1. Feedback linearization closed loop control scheme

or the nonlinear system given in (19), the state feedback/ feed-forward control law is given by:

$$u = a(x) + \beta(x)v - \gamma(x)d \tag{28}$$

with $a(x)$ and $\beta(x)$ as described in (27), and $\gamma(x) = M^{-1}(x)p(x)$.

3. Robust H_∞ controller design

To ensure stability and performance against modelling errors, the authors choose the method of McFarlane-Glover to design a robust linear controller for the feedback linearized system. The method of loop-shaping is chosen due to its ability to address robust performance and robust stability in two different stages of controller design (McFarlane and Glover, 1990).

The method of loopshaping consists of three steps:

Step 1. Open loop shaping

Using a pre-weighting matrix W_I and/or a post-weighting matrix W_o , the minimum and maximum singular values are modified to shape the response. This step results in an augmented matrix of the process transfer function: $P_s = W_o P W_I$.

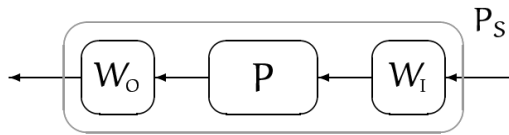

Fig. 2. Augmented matrix of the process transfer function

Step 2. Robust stability

The stability margin is computed as $\frac{1}{\epsilon_{\max}} = \inf_{K \text{ stabilizator}} \left\| \begin{bmatrix} I \\ K \end{bmatrix} (I - P_s K)^{-1} \tilde{M}_s^{-1} \right\|_\infty$, where

$P_s = \tilde{M}_s^{-1} \tilde{N}_s$ is the normalized left coprime factorization of the process transfer function matrix. If $\epsilon_{\max} \ll 1$, the pre and post weighting matrices have to be modified by relaxing the constraints imposed on the open loop shaping. If the value of ϵ_{\max} is acceptable, for a value $\epsilon < \epsilon_{\max}$ the resulting controller - K_a - is computed in order to satisfy the following relation:

$$\left\| \begin{bmatrix} I \\ K_a \end{bmatrix} (I - P_s K_a)^{-1} \tilde{M}_s^{-1} \right\|_\infty \leq \epsilon \tag{29}$$

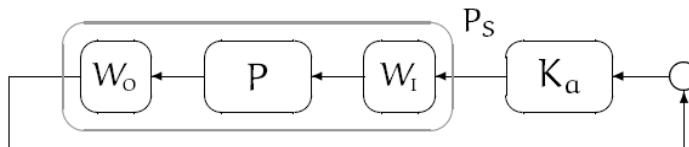

Fig. 3. Robust closed loop control scheme

Step 3. Final robust controller

The final resulting controller is given by the sub-optimal controller K_a weighted with the matrices W_I and/or W_o : $K = W_I K_a W_o$.

Using the McFarlane-Glover method, the loop shaping is done without considering the problem of robust stability, which is explicitly taken into account at the second design step, by imposing a stability margin for the closed loop system. This stability margin ϵ_{\max} is an indicator of the efficiency of the loopshaping technique.

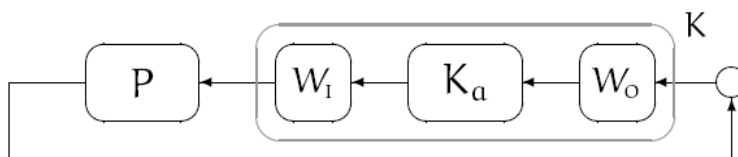

Fig. 4. Optimal controller obtained with the pre and post weighting matrices

The stability of the closed loop nonlinear system using robust stability and loopshaping is proven theoretically using W -stability (Guillard & Bourles, 2000; Franco *et al.*, 2006).

4. Case study: Reference tracking and disturbance rejection in an isothermal CSTR

The authors propose as an example, the control of an isothermal CSTR. A complete description of the steps required to obtain the final feedback linearization control scheme - in both approaches - is given. The robustness of the final nonlinear H_∞ controller is demonstrated through simulations concerning reference tracking and disturbance rejection, for the robust feedback linearization case.

4.1 The isothermal continuous stirred tank reactor

The application studied is an isothermal continuous stirred tank reactor process with first order reaction:



Different strategies have been proposed for this type of multivariable process (De Oliveira, 1994; Martinsen *et al.*, 2004; Chen *et al.*, 2010). The choice of the CSTR resides in its strong nonlinear character, which makes the application of a nonlinear control strategy based directly on the nonlinear model of the process preferable to classical linearization methods (De Oliveira, 1994).

The schematic representation of the process is given in Figure 5.

The tank reactor is assumed to be a well mixed one. The control system designed for such a process is intended to keep the liquid level in the tank - x_1 - constant, as well as the B product concentration - x_2 , extracted at the bottom of the tank. It is also assumed that the output flow rate F_o is determined by the liquid level in the reactor. The final concentration x_2 is obtained by mixing two input streams: a concentrated one u_1 , of concentration C_{B1} and a diluted one u_2 , of concentration C_{B2} . The process is therefore modelled as a multivariable system, having two manipulated variables, $u = [u_1 \ u_2]^T$ and two control outputs: $x = [x_1 \ x_2]^T$.

The process model is then given as:

$$\begin{aligned} \frac{dx_1}{dt} &= u_1 + u_2 - k_1\sqrt{x_1} \\ \frac{dx_2}{dt} &= (C_{B1} - x_2)\frac{u_1}{x_1} + (C_{B2} - x_2)\frac{u_2}{x_1} - \frac{k_2x_2}{(1+x_2)^2} \end{aligned} \tag{31}$$

with the parameters' nominal values given in table 1. The steady state operating conditions are taken as $x_{1ss}=100$ and $x_{2ss}=7.07$, corresponding to the input flow rates: $u_{1s} =1$ and $u_{2s} =1$. The concentrations of B in the input streams, C_{B1} and C_{B2} , are regarded as input disturbances.

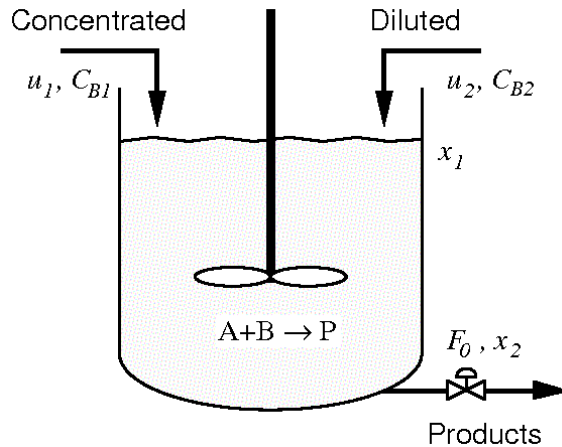

Fig. 5. Continuous stirred tank reactor (De Oliveira, 1994)

Parameter	Meaning	Nominal Value
C_{B1}	Concentration of B in the inlet flow u_1	24.9
C_{B2}	Concentration of B in the inlet flow u_2	0.1
k_1	Valve constant	0.2
k_2	Kinetic constant	1

Table 1. CSTR parameters and nominal values

From a feedback linearization point of view the process model given in (31) is rewritten as:

$$\begin{aligned} \begin{pmatrix} \dot{x}_1 \\ \dot{x}_2 \end{pmatrix} &= \begin{pmatrix} -k_1\sqrt{x_1} \\ -\frac{k_2x_2}{(1+x_2)^2} \end{pmatrix} + \begin{pmatrix} 1 \\ \frac{C_{B1} - x_2}{x_1} \end{pmatrix} u_1 + \begin{pmatrix} 1 \\ \frac{C_{B2} - x_2}{x_1} \end{pmatrix} u_2 \\ y &= [x_1 \quad x_2]^T \end{aligned} \tag{32}$$

yielding:

$$\begin{aligned} \begin{pmatrix} \dot{x}_1 \\ \dot{x}_2 \end{pmatrix} &= f(x) + g_1(x)u_1 + g_2(x)u_2 \\ y_1 &= h_1(x) = x_1 \\ y_2 &= h_2(x) = x_2 \end{aligned} \tag{33}$$

The relative degrees of each output are obtained based on differentiation:

$$\begin{aligned} \dot{y}_1 &= -k_1\sqrt{x_1} + u_1 + u_2 \\ \dot{y}_2 &= -\frac{k_2x_2}{(1+x_2)^2} + \frac{(C_{B1}-x_2)}{x_1}u_1 + \frac{(C_{B2}-x_2)}{x_1}u_2 \end{aligned} \tag{34}$$

thus yielding $r_1=1$ and $r_2=1$, respectively, with $r_1 + r_2 = 2$, the number of state variables of the nonlinear system (32). Since this is the case, the linearization will be exact, without any state variables rendered unobservable through feedback linearization.

The decoupling matrix $M(x)$ in (13), will be equal to:

$$M(x) = \begin{bmatrix} L_{g_1}(L_f^0 h_1) & L_{g_2}(L_f^0 h_2) \\ L_{g_1}(L_f^1 h_1) & L_{g_2}(L_f^1 h_2) \end{bmatrix} = \begin{bmatrix} 1 & 1 \\ \frac{(C_{B1}-x_2)}{x_1} & \frac{(C_{B1}-x_2)}{x_1} \end{bmatrix} \tag{35}$$

and is non-singular in the equilibrium point $x_0 = [100; 7.07]^T$.

The state transformation is given by:

$$x_c = [y_1 \ y_2]^T = [x_1 \ x_2]^T \tag{36}$$

while the control signal vector is:

$$u = -M^{-1}(x) \begin{bmatrix} L_f^1 h_1 \\ L_f^1 h_2 \end{bmatrix} + M^{-1}(x)v = \alpha_c(x) + \beta_c(x)v \tag{37}$$

with $\alpha_c(x) = -\begin{bmatrix} 1 & 1 \\ \frac{(C_{B1}-x_2)}{x_1} & \frac{(C_{B1}-x_2)}{x_1} \end{bmatrix}^{-1} \begin{bmatrix} -k_1\sqrt{x_1} \\ -\frac{k_2x_2}{(1+x_2)^2} \end{bmatrix}$ and $\beta_c(x) = \begin{bmatrix} 1 & 1 \\ \frac{(C_{B1}-x_2)}{x_1} & \frac{(C_{B1}-x_2)}{x_1} \end{bmatrix}^{-1}$.

In the next step, the L , T and R matrices needed for the robust feedback linearization method are computed:

$$L = -M(x_0)\partial_x a_c(x_0) = \begin{pmatrix} -0.1 \cdot 10^{-1} & 0 \\ -0.11 \cdot 10^{-2} & -0.84 \cdot 10^{-2} \end{pmatrix} \tag{38}$$

$$T = \partial_x x_c(x_0) = \begin{pmatrix} 1 & 0 \\ 0 & 1 \end{pmatrix} \tag{39}$$

$$R = M^{-1}(x_0) = \begin{pmatrix} 0.28 & 4.03 \\ 0.72 & -4.03 \end{pmatrix} \quad (40)$$

The control law can be easily obtained based on (27) as:

$$\begin{aligned} a(x) &= a_c(x) + \beta_c(x)LT^{-1}x_c \\ \beta(x) &= \beta_c(x)R^{-1} \end{aligned} \quad (41)$$

while the linearized system is given as:

$$\dot{z} = \begin{pmatrix} -\frac{k_1}{2}x_{10}^{-1/2} & 0 \\ 0 & \frac{k_2(x_{20}-1)}{(x_{20}+1)^3} \end{pmatrix} z + \begin{pmatrix} 1 & 1 \\ \frac{C_{B1}-7.07}{100} & \frac{C_{B2}-7.07}{100} \end{pmatrix} w \quad (42)$$

The linear H_∞ controller is designed using the McFarlane-Glover method (McFarlane, et al., 1989; Skogestad, et al., 2007) with loop-shaping that ensures the robust stabilization problem of uncertain linear plants, given by a normalized left co-prime factorization. The loop-shaping $P_s(s) = W(s)P(s)$, with $P(s)$ the matrix transfer function of the linear system given in (41), is done with the weighting matrix, W :

$$W = \text{diag}\left(\frac{14}{s} \quad \frac{10}{s}\right) \quad (43)$$

The choice of the weighting matrix corresponds to the performance criteria that need to be met. Despite robust stability, achieved by using a robust H_∞ controller, all process outputs need to be maintained at their set-point values. To keep the outputs at the prescribed set-points, the steady state errors have to be reduced. The choice of the integrators in the weighting matrix W above ensure the minimization of the output signals steady state errors. To keep the controller as simple as possible, only a pre-weighting matrix is used (Skogestad, et al., 2007). The resulting robust controller provides for a robustness of 38%, corresponding to a value of $\epsilon = 2.62$.

The simulation results considering both nominal values as well as modelling uncertainties are given in Figure 6. The results obtained using the designed nonlinear controller show that the closed loop control scheme is robust, the uncertainty range considered being of $\pm 20\%$ for k_1 and $\pm 30\%$ for k_2 .

A different case scenario is considered in Figure 7, in which the input disturbances C_{B1} and C_{B2} have a +20% deviation from the nominal values. The simulation results show that the nonlinear robust controller, apart from its robustness properties, is also able to reject input disturbances.

To test the output disturbance rejection situation, the authors consider an empiric model of a measurable disturbance that has a direct effect on the output vector. To consider a general situation from a feedback linearization perspective, the nonlinear model in (33) is altered to model the disturbance, $d(t)$, as:

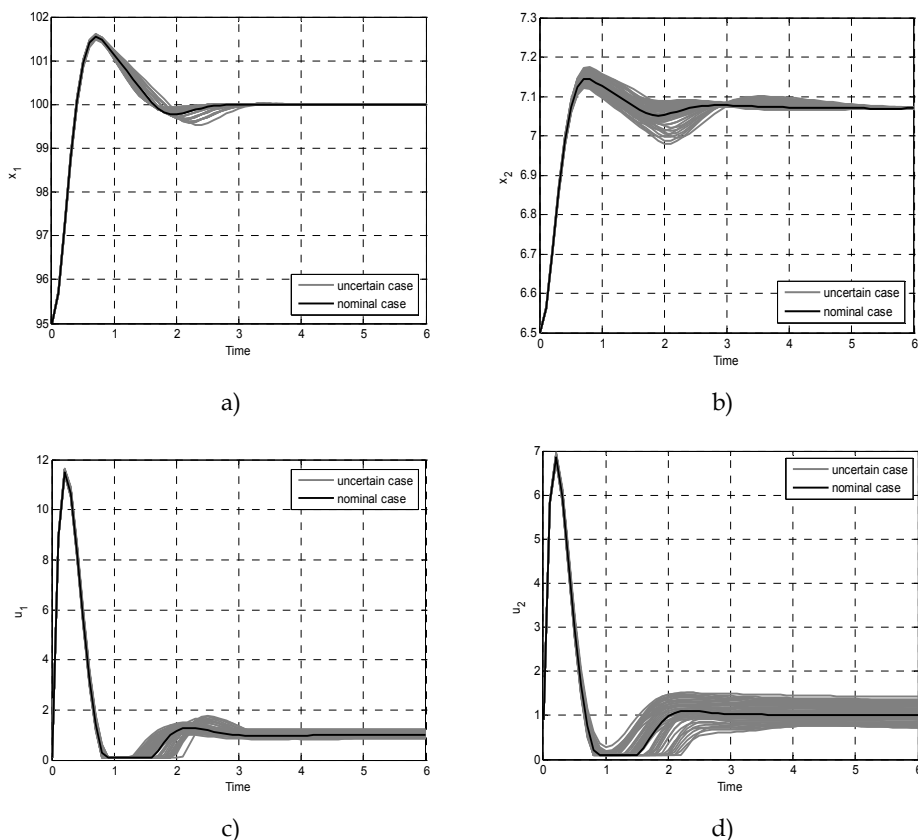

Fig. 6. Closed loop simulations using robust nonlinear controller a) x_1 b) x_2 c) u_1 d) u_2

$$\begin{aligned} \begin{pmatrix} \dot{x}_1 \\ \dot{x}_2 \end{pmatrix} &= f(x) + g_1(x)u_1 + g_2(x)u_2 + p(x)d \\ y_1 &= h_1(x) = x_1 \\ y_2 &= h_2(x) = x_2 \end{aligned} \tag{44}$$

with $p(x)$ taken to be dependent on the output vector:

$$p(x) = \begin{pmatrix} x_1 \\ x_2 \end{pmatrix} \tag{45}$$

The relative degrees of the disturbance to the outputs of interest are: $\gamma_1 = 1$ and $\gamma_2 = 1$. Since the relative degrees of the disturbances to the outputs are equal to those of the inputs, a simple static feed-forward structure can be used for output disturbance rejection purposes, with the control law given in (28), with $\alpha(x)$ and $\beta(x)$ determined according to (27) and $\gamma(x)$ being equal to:

$$\gamma(x) = M^{-1}(x)p(x) = \begin{bmatrix} 1 & 1 \\ \frac{C_{B1} - x_2}{x_1} & \frac{C_{B1} - x_2}{x_1} \end{bmatrix}^{-1} \begin{pmatrix} x_1 \\ x_2 \end{pmatrix} \quad (46)$$

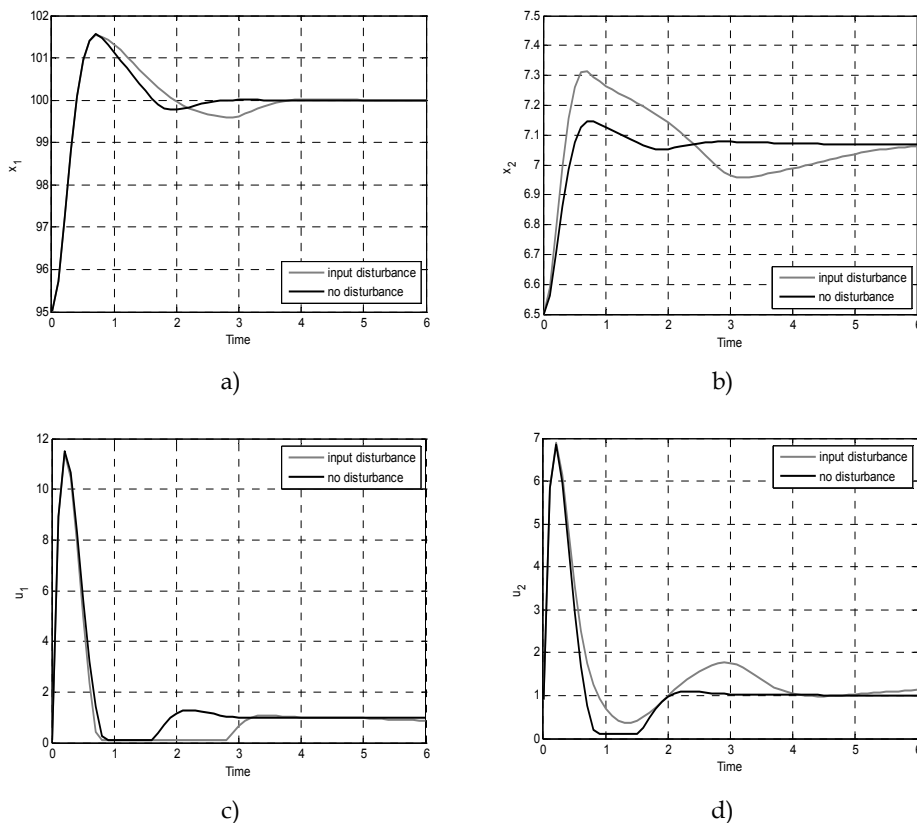

Fig. 7. Input disturbance rejection using robust nonlinear controller a) x_1 b) x_2 c) u_1 d) u_2

The simulation results considering a unit disturbance d are given in Figure 8, considering a time delay in the sensor measurements of 1 minute. The results show that the state feedback/feed-forward scheme proposed in the robust feedback linearization framework is able to reject measurable output disturbances. A comparative simulation is given considering the case of no feed-forward scheme. The results show that the use of the feed-forward scheme in the feedback linearization loop reduces the oscillations in the output, with the expense of an increased control effort.

In the unlikely situation of no time delay measurements of the disturbance d , the results obtained using feed-forward compensator are highly notable, as compared to the situation without the compensator. The simulation results are given in Figure 9. Both, Figure 8 and Figure 9 show the efficiency of such feed-forward control scheme in output disturbance rejection problems.

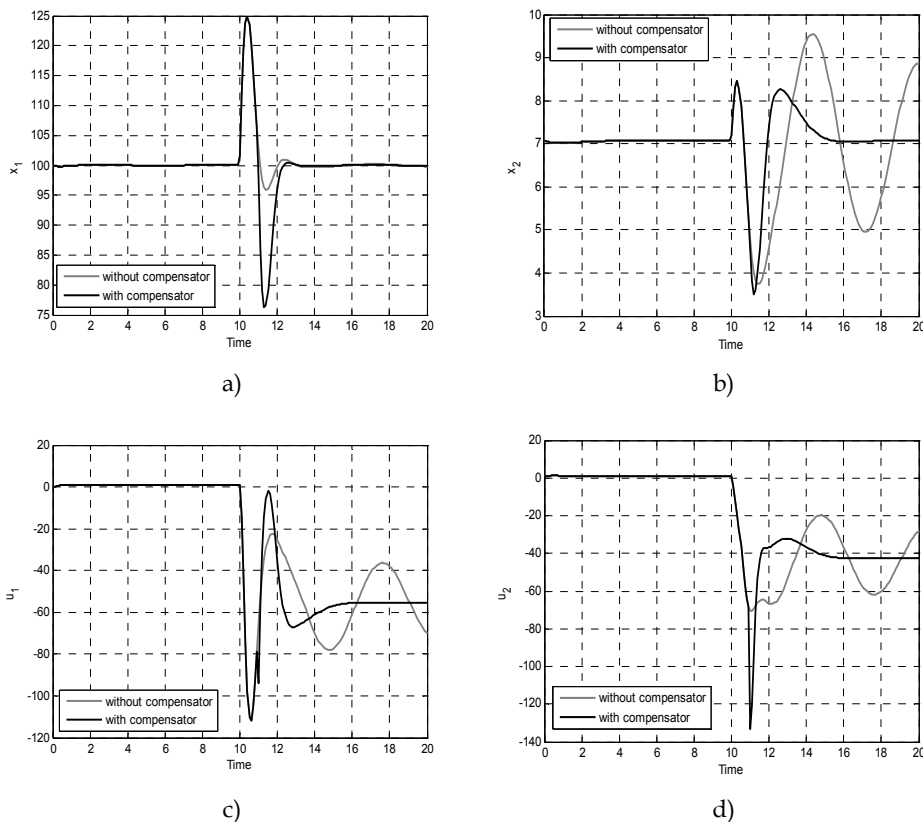

Fig. 8. Output disturbance rejection using robust nonlinear controller and feed-forward compensator considering time delay measurements of the disturbance d a) x_1 b) x_2 c) u_1 d) u_2

5. Conclusions

As it has been previously demonstrated theoretically through mathematical computations (Guillard, *et al.*, 2000), the results in this paper prove that by combining the robust method of feedback linearization with a robust linear controller, the robustness properties are kept when simulating the closed loop nonlinear uncertain system. Additionally, the design of the loop-shaping controller is significantly simplified as compared to the classical linearization technique, since the final linearized model bears significant information regarding the initial nonlinear model. Finally, the authors show that robust nonlinear controller - designed by combining this new method for feedback linearization (Guillard & Bourles, 2000) with a linear H_∞ controller - offers a simple and efficient solution, both in terms of reference tracking and input disturbance rejection. Moreover, the implementation of the feed-forward control scheme in the state-feedback control structure leads to improved output disturbance rejection.

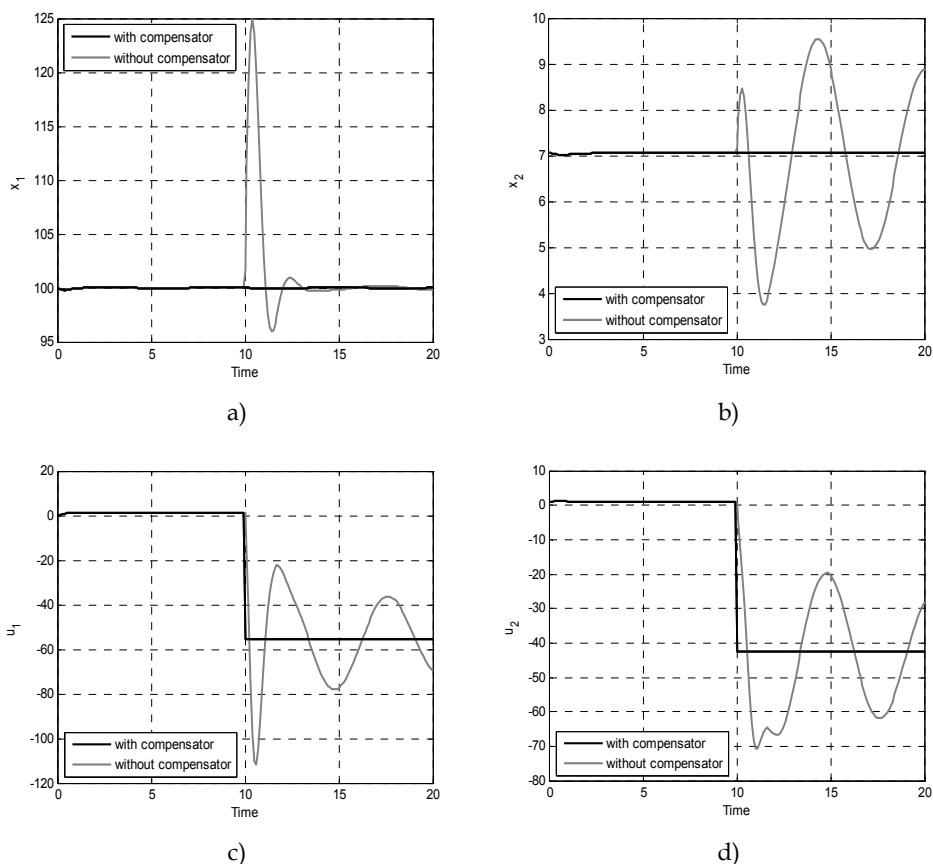

Fig. 9. Output disturbance rejection using robust nonlinear controller and feed-forward compensator considering instant measurements of the disturbance d a) x_1 b) x_2 c) u_1 d) u_2

6. References

- Barkhordari Yazdi, M., & Jahed-Motlagh, M.R. (2009), Stabilization of a CSTR with two arbitrarily switching modes using modal state feedback linearization, In: *Chemical Engineering Journal*, vol. 155, pp. 838-843, ISSN: 1385-8947
- Chen, P., Lu, I.-Z., & Chen, Y.-W. (2010), Extremal Optimization Combined with LM Gradient Search for MLP Network Learning, *International Journal of Computational Intelligence Systems*, Vol.3, No. 5, pp. 622-631, ISSN: 1875-6891
- Chou, YI-S., & Wu, W. (1995), Robust controller design for uncertain nonlinear systems via feedback linearization, In: *Chemical Engineering Science*, vol. 50, No. 9, pp. 1429-1439, ISSN: 0009-2509
- Dabo, M., Langlois, & N., Chafouk, H. (2009), Dynamic feedback linearization applied to asymptotic tracking: Generalization about the turbocharged diesel engine outputs

- choice, In: *Proceedings of the American Control Conference ACC'09*, ISBN: 978-1-4244-4524-0, pp. 3458 – 3463, St. Louis, Missouri, USA, 10-12 June 2009
- Daoutidis, P., & Kravaris, C. (1989), Synthesis of feedforward/state feedback controllers for nonlinear processes, In: *AIChE Journal*, vol. 35, pp.1602-1616, ISSN: 1547-5905
- Daoutidis, P., Soruosh, M, & Kravaris, C. (1990), Feedforward-Feedback Control of Multivariable Nonlinear Processes, In: *AIChE Journal*, vol. 36, no.10, pp.1471-1484, ISSN: 1547-5905
- Franco, A.L.D., Bourles, H., De Pieri, E.R., & Guillard, H. (2006), Robust nonlinear control associating robust feedback linearization and H_∞ control, In: *IEEE Transactions on Automatic Control*, vol. 51, No. 7, pp. 1200-1207, ISSN: 0018-9286
- Franco, A.L.D., Bourles, H., & De Pieri, E.R. (2005), A robust nonlinear controller with application to a magnetic bearing, In: *Proceedings of the 44th IEEE Conference on Decision and Control and The European Control Conference*, ISBN: 0-7803-9567-0, Seville, Spain, 12-15 December 2005
- Guillard, H., & Bourles, H. (2000), Robust feedback linearization, In: *Proc. 14th International Symposium on Mathematical Theory of Networks and Systems*, Perpignan, France, 19-23 June 2000
- Isidori, A. (1995), *Nonlinear control systems*, Springer-Verlag, ISBN: 3540199160, New York, USA
- Martinesn, F., Biegler, L. T., & Foss, B. A. (2004), A new optimization algorithm with application to nonlinear MPC, *Journal of Process Control*, vol. 14, No. 8, pp. 853-865, ISSN: 0959-1524
- McFarlane, D.C, & Glover, K. (1990), Robust controller design using normalized coprime factor plant descriptions, In: *Lecture Notes in Control and Information Sciences*, vol. 138, Springer Verlag, New York, USA, ISSN: 0170-8643
- De Oliveira, N. M. C (1994), *Newton type algorithms for nonlinear constrained chemical process control*, PhD thesis, Carnegie Melon University, Pennsylvania
- Pop, C.I, Dulf, E., & Festila, Cl. (2009), Nonlinear Robust Control of the ¹³C Cryogenic Isotope Separation Column, In: *Proceedings of the 17th International Conference on Control Systems and Computer Science*, Vol.2., pp.59-65, ISSN: 2066-4451, Bucharest, Romania, 26-29 May 2009
- Pop, C.-I., & Dulf, E.-H. (2010), Control Strategies of the ¹³C Cryogenic Separation Column, *Control Engineering and Applied Informatics*, Vol. 12, No. 2, pp.36-43, June 2010, ISSN 1454-8658
- Pop, C.I., Dulf, E., Festila, Cl., & Muresan, B. (2010), Feedback Linearization Control Design for the ¹³C Cryogenic Separation Column, In: *International IEEE-TTTC International Conference on Automation, Quality and Testing, Robotics AQTR 2010*, vol. I, pp. 157-163, ISBN: 978-1-4244-6724-2, Cluj-Napoca, Romania, 28-30 May 2010
- Robenack, K. (2005), Automatic differentiation and nonlinear controller design by exact linearization, In: *Future Generation Computer Systems*, vol. 21, pp. 1372-1379, ISSN: 0167-739X
- Seo, J., Venugopala, & R., Kenne, J.-P. (2007), Feedback linearization based control of a rotational hydraulic drive, In: *Control Engineering Practice*, vol. 15, pp. 1495-1507, ISSN: 0967-0661

- Sastry, S. S. (1999), *Nonlinear systems: analysis, stability and control*, Springer Verlag, ISBN: 0-387-98513-1, New York, USA
- Henson, M., & Seborg, D. (Eds.),(1997), *Nonlinear process control*, Prentice Hall, ISBN: 978-0136251798, New York, USA



Recent Advances in Robust Control - Novel Approaches and Design Methods

Edited by Dr. Andreas Mueller

ISBN 978-953-307-339-2

Hard cover, 462 pages

Publisher InTech

Published online 07, November, 2011

Published in print edition November, 2011

Robust control has been a topic of active research in the last three decades culminating in H_2/H_∞ and μ design methods followed by research on parametric robustness, initially motivated by Kharitonov's theorem, the extension to non-linear time delay systems, and other more recent methods. The two volumes of Recent Advances in Robust Control give a selective overview of recent theoretical developments and present selected application examples. The volumes comprise 39 contributions covering various theoretical aspects as well as different application areas. The first volume covers selected problems in the theory of robust control and its application to robotic and electromechanical systems. The second volume is dedicated to special topics in robust control and problem specific solutions. Recent Advances in Robust Control will be a valuable reference for those interested in the recent theoretical advances and for researchers working in the broad field of robotics and mechatronics.

How to reference

In order to correctly reference this scholarly work, feel free to copy and paste the following:

Cristina Ioana Pop and Eva Henrietta Dulf (2011). Robust Feedback Linearization Control for Reference Tracking and Disturbance Rejection in Nonlinear Systems, Recent Advances in Robust Control - Novel Approaches and Design Methods, Dr. Andreas Mueller (Ed.), ISBN: 978-953-307-339-2, InTech, Available from: <http://www.intechopen.com/books/recent-advances-in-robust-control-novel-approaches-and-design-methods/robust-feedback-linearization-control-for-reference-tracking-and-disturbance-rejection-in-nonlinear->

INTECH

open science | open minds

InTech Europe

University Campus STeP Ri
Slavka Krautzeka 83/A
51000 Rijeka, Croatia
Phone: +385 (51) 770 447
Fax: +385 (51) 686 166
www.intechopen.com

InTech China

Unit 405, Office Block, Hotel Equatorial Shanghai
No.65, Yan An Road (West), Shanghai, 200040, China
中国上海市延安西路65号上海国际贵都大饭店办公楼405单元
Phone: +86-21-62489820
Fax: +86-21-62489821